



# Invariant cover: Existence, cardinality bounds, and computation<sup>☆</sup>

Yulong Gao<sup>a,c,\*</sup>, Mark Cannon<sup>b</sup>, Lihua Xie<sup>c</sup>, Karl Henrik Johansson<sup>a</sup>

<sup>a</sup> School of Electrical Engineering and Computer Science, KTH Royal Institute of Technology, SE 10044, Stockholm, Sweden

<sup>b</sup> Department of Engineering Science, University of Oxford, Oxford, OX1 3PJ, UK

<sup>c</sup> School of Electrical and Electronic Engineering, Nanyang Technological University, 639798, Singapore

## ARTICLE INFO

### Article history:

Received 5 April 2020

Received in revised form 19 January 2021

Accepted 3 February 2021

Available online 5 April 2021

### Keywords:

Invariant cover

Invariance feedback entropy

Networked control systems

## ABSTRACT

An invariant cover quantifies the information needed by a controller to enforce an invariance specification. This paper investigates some fundamental problems concerning existence and computation of an invariant cover for uncertain discrete-time linear control systems subject to state and control constraints. We develop necessary and sufficient conditions on the existence of an invariant cover for a polytopic set of states. The conditions can be checked by solving a set of linear programs, one for each extreme point of the state set. Based on these conditions, we give upper and lower bounds on the minimal cardinality of the invariant cover, and design an iterative algorithm with finite-time convergence to compute an invariant cover. We further show in two examples how to use an invariant cover in the design of a coder–controller pair that ensures invariance of a given set for a networked control system with a finite communication data rate.

© 2021 The Authors. Published by Elsevier Ltd. This is an open access article under the CC BY-NC-ND license (<http://creativecommons.org/licenses/by-nc-nd/4.0/>).

## 1. Introduction

In a networked control system a plant is connected with a controller through a communication network (Bemporad, Heemels, & Johansson, 2010; Sinopoli et al., 2004; Zhang, Branicky, & Phillips, 2001), as shown in Fig. 1. Networked control systems are in widespread use in a variety of application areas, for example, smart buildings (Agarwal et al., 2010) and intelligent transportation (Zhou, Cao, Zeng, & Wu, 2010). Since the data rate of a communication channel is usually limited, a central question is how much information is needed by the controller to enforce a given specification.

Feedback control under limited data rate has been widely studied (Nair & Evans, 2003; Nair, Fagnani, Zampieri, & Evans, 2007; Tatikonda & Mitter, 2004). One well-known result is that the critical data rate necessary for stabilization of linear systems depends on the unstable poles of their open-loop system. In Nair,

Evans, Mareels, and Moran (2004), the notion of topological feedback entropy, which is an extension of topological entropy (Adler, Konheim, & McAndrew, 1965; Bowen, 1971), has been used to quantify the information necessary for stabilization of nonlinear control systems.

Invariance is one of the most fundamental concepts in systems and control (Blanchini, 1999; Blanchini & Miani, 2007). In the context of networked control systems, the minimal data rate necessary for set invariance under feedback control was studied in Kawan (2013) and Nair et al. (2004). It was shown in Nair et al. (2004) that a finite topological feedback entropy is necessary to achieve invariance. Later, the notion of invariance entropy was proposed for continuous-time deterministic control systems based on spanning sets (Kawan, 2013). Equivalence between these two notions was established for discrete-time control systems under the assumption of strong invariance in Colonius, Kawan, and Nair (2013).

The notion of invariance feedback entropy was first proposed in Rungger and Zamani (2017a) for generalizing the notion of invariance entropy (Kawan, 2013) to uncertain discrete-time control systems and was further explored in Rungger and Zamani (2017b), Tomar, Rungger, and Zamani (2020). It was shown in Tomar et al. (2020) that the invariance feedback entropy of a given set of states is finite if and only if an invariant cover exists for this set. An invariant cover is a pair consisting of a finite cover of the given set and a map from this cover to the control set (see Definition 2.2). We remark that the invariant cover plays an important role in designing a coder–controller which achieves a finite data rate and ensures invariance.

<sup>☆</sup> The work of Yulong Gao and Karl H. Johansson was supported in part by the Knut and Alice Wallenberg Foundation, Sweden, the Swedish Foundation for Strategic Research, and the Swedish Research Council. The material in this paper was not presented at any conference. This paper was recommended for publication in revised form by Associate Editor Luca Schenato under the direction of Editor Christos G. Cassandras.

\* Corresponding author at: School of Electrical Engineering and Computer Science, KTH Royal Institute of Technology, SE 10044, Stockholm, Sweden and School of Electrical and Electronic Engineering, Nanyang Technological University, 639798, Singapore.

E-mail addresses: [yulongg@kth.se](mailto:yulongg@kth.se) (Y. Gao), [mark.cannon@eng.ox.ac.uk](mailto:mark.cannon@eng.ox.ac.uk) (M. Cannon), [elhxie@ntu.edu.sg](mailto:elhxie@ntu.edu.sg) (L. Xie), [kallej@kth.se](mailto:kallej@kth.se) (K.H. Johansson).

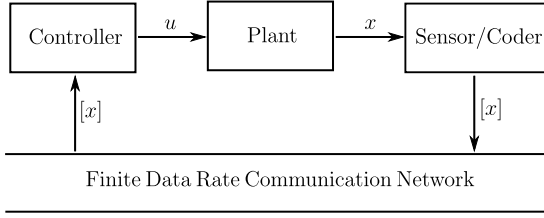

Fig. 1. Coder-controller feedback loop, where  $x$  is the measured state,  $[x]$  is the encoded state, and  $u$  is the control.

This paper establishes fundamental results on invariant cover for uncertain discrete-time linear control systems. The main contributions are summarized as follows:

- We develop two necessary and sufficient conditions for the existence of an invariant cover for a given polytopic set (Theorems 3.1 and 3.2). They suggest a computationally tractable method of determining whether an invariant cover exists through linear programming.
- Based on these conditions, we give upper and lower bounds on the minimal cardinality of an invariant cover (Theorem 4.1). As a complement to Tomar et al. (2020), this upper bound is valid for the invariance feedback entropy and the minimal data rate necessary for invariance.
- We provide an iterative algorithm to compute an invariant cover (Algorithm 1) and prove its finite-time convergence (Theorem 5.1). The performance of the algorithm is illustrated in two examples that use an invariant cover to design a static coder-controller pair for a networked control system with a finite data rate to enforce the invariance of a given set.

The remainder of the paper is organized as follows. The problem statement is given in Section 2. Section 3 addresses the existence of an invariant cover and Section 4 gives bounds on its minimal cardinality. Section 5 provides an algorithm for computing an invariant cover. The examples in Section 6 detail how to use the invariant cover to design coder-controllers for networked control systems. Section 7 concludes the paper.

**Notation.**  $\mathbb{N}$  is the set of nonnegative integers and  $\mathbb{R}$  is the set of real numbers. For  $q, s \in \mathbb{N}$  with  $q < s$ , the sets  $\{r \in \mathbb{N} \mid r \geq q\}$  and  $\{r \in \mathbb{N} \mid q \leq r \leq s\}$  are denoted by  $\mathbb{N}_{\geq q}$  and  $\mathbb{N}_{[q,s]}$ , respectively. The  $i$ th row and  $(i, j)$ -th element of a matrix  $A \in \mathbb{R}^{r \times n}$  are denoted as  $[A]_i \in \mathbb{R}^{1 \times n}$  and  $[A]_{ij}$ , respectively. Inequalities involving vectors are interpreted element-wise and  $\mathbf{1}$  is the vector  $[1 \cdots 1]^T$  with dimension dependent on context. The Euclidean ball with center  $x \in \mathbb{R}^n$  and radius  $r \in \mathbb{R}_{>0}$  is  $\mathbb{B}_r(x) = \{z \in \mathbb{R}^n \mid \|z - x\|_2 \leq r\}$ , where  $\|\cdot\|_2$  is the Euclidean norm. For sets  $\mathbb{X}, \mathbb{Y} \subseteq \mathbb{R}^n$ , the convex hull of  $\mathbb{X}$  is denoted by  $\text{conv}(\mathbb{X})$ , and the Minkowski sum and Pontryagin difference are denoted by  $\mathbb{X} \oplus \mathbb{Y} = \{x + y \mid x \in \mathbb{X}, y \in \mathbb{Y}\}$  and  $\mathbb{X} \ominus \mathbb{Y} = \{x \mid x + y \in \mathbb{X}, \forall y \in \mathbb{Y}\}$ . For  $\alpha \in \mathbb{R}$  and  $A \in \mathbb{R}^{r \times n}$  we define  $\alpha\mathbb{X} = \{\alpha x \mid x \in \mathbb{X}\}$  and  $A\mathbb{X} = \{Ax \mid x \in \mathbb{X}\}$ . The extreme points (vertices) of a polytope  $\mathbb{P}$  are denoted  $\text{vert}(\mathbb{P})$ , and for  $\mathbb{P} = \{x \in \mathbb{R}^n \mid Vx \leq v\}$  with  $V \in \mathbb{R}^{r \times n}$ ,  $v \in \mathbb{R}^r$  and  $k \in \mathbb{N}_{[1,r]}$ , we denote  $\text{vert}_k(\mathbb{P}) = \{x \in \text{vert}(\mathbb{P}) \mid [V]_k x < [v]_k\}$ .

## 2. Problem statement

Consider a discrete-time linear system in the form of

$$x_{k+1} = Ax_k + Bu_k + w_k, \quad (1)$$

where  $x_k \in \mathbb{X} \subseteq \mathbb{R}^{n_x}$  is the state,  $u_k \in \mathbb{U} \subset \mathbb{R}^{n_u}$  the control input and  $w_k \in \mathbb{W} \subset \mathbb{R}^{n_x}$  the disturbance input, and  $A, B$  are

matrices with appropriate dimensions. The state and control sets  $\mathbb{X}$  and  $\mathbb{U}$  and the disturbance set  $\mathbb{W}$  are each assumed to be convex polyhedral sets:

$$\mathbb{X} \triangleq \{x \in \mathbb{R}^{n_x} \mid F_x x \leq f_x\}, \quad (2)$$

$$\mathbb{U} \triangleq \{u \in \mathbb{R}^{n_u} \mid F_u u \leq f_u\}, \quad (3)$$

$$\mathbb{W} \triangleq \{w \in \mathbb{R}^{n_x} \mid F_w w \leq f_w\}, \quad (4)$$

where  $F_x, F_u, F_w$ , and  $f_x, f_u, f_w$  are matrices and vectors with appropriate dimensions. We assume that  $\mathbb{U}$  and  $\mathbb{W}$  are compact sets and define  $\mathbb{Q}$  as a compact subset of  $\mathbb{X}$ .<sup>1</sup>

**Definition 2.1.** A set  $\mathbb{Q} \subseteq \mathbb{X}$  is said to be a *robust controlled invariant set* (RCIS) if for each  $x \in \mathbb{Q}$ , there exists a control input  $u \in \mathbb{U}$  such that  $Ax + Bu \in \mathbb{Q} \ominus \mathbb{W}$ .

**Remark 2.1.** An RCIS is a set that can be made invariant by a state feedback control law under any admissible disturbance. The computation of such sets is widely studied in the literature, e.g., Rungger and Tabuada (2017).

A cover of a set  $\mathbb{Q}$  is a collection of sets whose union includes  $\mathbb{Q}$  as a subset. Next we define an invariant cover of  $\mathbb{Q} \subseteq \mathbb{X}$ , which is a pair consisting of a finite cover of  $\mathbb{Q}$  and a map from this cover to the control set  $\mathbb{U}$ . Each state set from the finite cover can be driven to the set  $\mathbb{Q}$  by means of a single control input generated by the map.

**Definition 2.2** (Tomar et al., 2020). A cover  $\mathcal{A}$  of a nonempty set  $\mathbb{Q}$  and a function  $G : \mathcal{A} \rightarrow \mathbb{U}$  is an *invariant cover*  $(\mathcal{A}, G)$  of the system (1) and  $\mathbb{Q}$  if  $\mathcal{A}$  is finite and, for all  $\mathbb{X}^{ic} \in \mathcal{A}$ ,  $A\mathbb{X}^{ic} \oplus \{BG(\mathbb{X}^{ic})\} \subseteq \mathbb{Q} \ominus \mathbb{W}$ .

**Remark 2.2.** In the context of networked control systems, an invariant cover is used to define the invariance feedback entropy in Tomar et al. (2020). Note that an invariant cover  $(\mathcal{A}, G)$  immediately provides a static coder-controller: for any  $x \in \mathbb{Q}$ , the coder transmits one of the sets  $\mathbb{X}^{ic} \in \mathcal{A}$  that contains  $x$  to the controller and the controller implements  $G(\mathbb{X}^{ic})$  to guarantee invariance (Fig. 1). In Tomar et al. (2020), the data rate of the static coder-controller under the invariant cover  $(\mathcal{A}, G)$  is defined to be  $\log_2 |\mathcal{A}|$  bits per time unit.

**Example 2.1.** Consider the linear scalar system

$$x_{k+1} = 2x_k + u_k + w_k,$$

with  $\mathbb{X} = \mathbb{R}$ ,  $\mathbb{U} = [-1, 1]$ , and  $\mathbb{W} = [-0.4, 0.4]$ . Let  $\mathbb{Q} = [-0.6, 0.6]$ . It is easy to verify that  $\mathbb{Q}$  is an RCIS. Let  $\mathbb{X}_1^{ic} = [-0.6, -0.4]$ ,  $\mathbb{X}_2^{ic} = [-0.4, -0.2]$ ,  $\mathbb{X}_3^{ic} = [-0.2, 0]$ ,  $\mathbb{X}_4^{ic} = [0, 0.2]$ ,  $\mathbb{X}_5^{ic} = [0.2, 0.4]$ , and  $\mathbb{X}_6^{ic} = [0.4, 0.6]$ . Define  $\mathcal{A} = \{\mathbb{X}_i^{ic}\}_{i=1}^6$  and the map  $G : \mathcal{A} \rightarrow \mathbb{U}$  with  $G(\mathbb{X}_1^{ic}) = 1$ ,  $G(\mathbb{X}_2^{ic}) = 0.6$ ,  $G(\mathbb{X}_3^{ic}) = 0.2$ ,  $G(\mathbb{X}_4^{ic}) = -0.2$ ,  $G(\mathbb{X}_5^{ic}) = -0.6$ , and  $G(\mathbb{X}_6^{ic}) = -1$ . We can verify that  $(\mathcal{A}, G)$  is an invariant cover for this system and the set  $\mathbb{Q}$ . The data rate of the static coder-controller defined by this invariant cover  $(\mathcal{A}, G)$  is  $\log_2 6$  bits per time unit.

From Definition 2.2 it is obvious that  $\mathbb{Q}$  must be an RCIS in order that there exists an invariant cover  $(\mathcal{A}, G)$  of the system (1) and  $\mathbb{Q}$ . In this paper, we firstly consider the existence of an invariant cover.

<sup>1</sup> We assume that  $\mathbb{Q}$  is full-dimensional. If this is not the case, i.e., if  $\mathbb{Q}$  lies in an affine subspace of  $\mathbb{R}^{n_x}$ , then we assume that  $\mathbb{Q} \subseteq \mathbb{S}_1 \times \mathbb{S}_2$  and  $\mathbb{Q} \cap \mathbb{S}_1 = \{x^0\}$  for some  $x^0 \in \mathbb{R}^{n_x}$ , and we apply the following arguments to the subspace  $\mathbb{S}_2$  and the projection of  $\mathbb{Q}$  (assumed full-dimensional) onto  $\mathbb{S}_2$ .

**Problem 2.1.** Consider the system (1) and a set  $\mathbb{Q}$ . Find necessary and sufficient conditions such that there exists an invariant cover  $(\mathcal{A}, G)$  of the system (1) and the set  $\mathbb{Q}$ .

From Remark 2.2 it follows that the data rate of the (static) coder–controller decreases as the cardinality of the invariant cover decreases. We define the minimal cardinality of the invariant cover as follows:

$$|\mathcal{A}|^* = \inf |\mathcal{A}| \quad \text{s.t.} \quad (\mathcal{A}, G) \text{ is an invariant cover for (1) and } \mathbb{Q}.$$

If an invariant cover is known to exist, we consider the following problem.

**Problem 2.2.** If an invariant cover  $(\mathcal{A}, G)$  exists for the system (1) and a set  $\mathbb{Q}$ , provide upper and lower bounds on the minimal cardinality of the invariant cover.

We further consider the computation problem.

**Problem 2.3.** Design an algorithm to compute an invariant cover  $(\mathcal{A}, G)$  for the system (1) and a set  $\mathbb{Q}$  whenever such invariant cover exists.

### 3. Existence of an invariant cover

This section focuses on Problem 2.1. The sets  $\mathbb{Q}$  and  $\mathbb{Q} \ominus \mathbb{W}$  are assumed to have the H-representations

$$\mathbb{Q} = \{x \in \mathbb{R}^{n_x} \mid Qx \leq q\}, \quad (5)$$

$$\mathbb{Q} \ominus \mathbb{W} = \{x \in \mathbb{R}^{n_x} \mid Px \leq p\}, \quad (6)$$

where  $q \in \mathbb{R}^{n_q}$ ,  $p \in \mathbb{R}^{n_p}$  and  $Q, P$  are matrices with appropriate dimensions. We assume that the rows of  $Q$  are normalized so that  $\|Q_i\|_2 = 1, \forall i \in \mathbb{N}_{[1, n_q]}$ , and that  $q > 0$  so that the origin lies in the interior of  $\mathbb{Q}$ .<sup>2</sup>

For  $x \in \mathbb{Q}$ , we say that a control  $u$  is feasible for  $x$  if it drives  $x$  to  $\mathbb{Q}$  for all  $w \in \mathbb{W}$ . We denote by  $\Gamma \subseteq \mathbb{R}^{n_x + n_u}$  the set of all  $(x, u)$  such that  $u$  is feasible for  $x$ . The set  $\Gamma$  can be written as a compact polytopic set:

$$\Gamma = \left\{ (x, u) \in \mathbb{R}^{n_x} \times \mathbb{R}^{n_u} \mid \underbrace{Qx \leq q}_{x \in \mathbb{Q}}, \underbrace{F_u u \leq f_u}_{u \in \mathbb{U}}, \underbrace{PAx + PBu \leq p}_{Ax + Bu \in \mathbb{Q} \ominus \mathbb{W}} \right\}. \quad (7)$$

Define the map  $\Pi : \mathbb{U} \rightarrow 2^{\mathbb{R}^{n_x}}$  as

$$\Pi(u) = \{x \in \mathbb{R}^{n_x} \mid (x, u) \in \Gamma\}. \quad (8)$$

For convenience we set  $\Pi(u) = \emptyset$  if  $u \notin \mathbb{U}$ . For given  $u \in \mathbb{U}$ , the set  $\Pi(u)$  has the property that any state  $x \in \Pi(u)$  is steered into  $\mathbb{Q}$  by  $u$  in a single time-step.

**Lemma 3.1.** For any given  $u \in \mathbb{U}$ , if  $\Pi(u) \neq \emptyset$ , then  $A\Pi(u) \oplus \{Bu\} \subseteq \mathbb{Q} \ominus \mathbb{W}$ .

**Proof.** If  $\Pi(u) \neq \emptyset$ , then (7)–(8) imply that  $Ax + Bu \subseteq \mathbb{Q} \ominus \mathbb{W}$  for all  $x \in \Pi(u)$ , i.e.,  $A\Pi(u) \oplus \{Bu\} \subseteq \mathbb{Q} \ominus \mathbb{W}$ .  $\square$

The following lemma gives a necessary and sufficient condition for the existence of an invariant cover.

<sup>2</sup> For any full-dimensional  $\mathbb{Q}$  this can be ensured by redefining the state and disturbance input of (1) as  $x_k - x^0$  and  $w_k - x^0 + Ax^0$ , respectively, for any  $x^0$  in the interior of  $\mathbb{Q}$ .

**Lemma 3.2.** An invariant cover  $(\mathcal{A}, G)$  of the system (1) and the set  $\mathbb{Q}$  exists if and only if there exist a finite number  $N \in \mathbb{N}$  and a set  $\{u_i \in \mathbb{U}\}_{i=1}^N$  such that

$$\bigcup_{i=1}^N \Pi(u_i) = \mathbb{Q}. \quad (9)$$

**Proof.** See Appendix.

Lemma 3.2 is important to prove the following result.

**Theorem 3.1.** An invariant cover  $(\mathcal{A}, G)$  of the system (1) and the set  $\mathbb{Q}$  exists if and only if for all  $x \in \mathbb{Q}$ , there exists a control input  $u \in \mathbb{U}$  such that  $\mathbb{B}_r(x) \cap \mathbb{Q} \subseteq \Pi(u)$  for some  $r > 0$ .

**Proof.** See Appendix.

We note that there is no obvious computationally tractable method of checking the necessary and sufficient conditions of Lemma 3.2 and Theorem 3.1.

#### 3.1. Optimization-based existence condition

This subsection provides computationally tractable necessary and sufficient conditions for the existence of an invariant cover for a given set  $\mathbb{Q}$ . To avoid the computational difficulties of checking the conditions of Theorem 3.1 based on  $\mathbb{B}_r(x) \cap \mathbb{Q}$ , we consider instead the set  $\bar{\mathcal{X}}(x, \alpha)$  defined for  $x \in \mathbb{Q}$ ,  $\alpha \in [0, 1]$  by

$$\bar{\mathcal{X}}(x, \alpha) = \{z \in \mathbb{R}^{n_x} \mid Q(z - (1 - \alpha)x) \leq \alpha q\}.$$

This set can be equivalently expressed as

$$\bar{\mathcal{X}}(x, \alpha) = \{(1 - \alpha)x\} \oplus \alpha\mathbb{Q}, \quad (10)$$

so we therefore have  $x \in \bar{\mathcal{X}}(x, \alpha) \subseteq \mathbb{Q}$ , for all  $x \in \mathbb{Q}$  and  $\alpha \in [0, 1]$ . It also follows from (10) that  $\bar{\mathcal{X}}(x, \alpha)$  is monotonically non-decreasing with  $\alpha$ , i.e.,  $\bar{\mathcal{X}}(x, \alpha_1) \subseteq \bar{\mathcal{X}}(x, \alpha_2)$ , for all  $x \in \mathbb{Q}$  and  $0 \leq \alpha_1 \leq \alpha_2 \leq 1$ .

The results of this section rely on the following two lemmas, which are derived from the convexity and linearity of the conditions defining  $\Pi(u)$  and  $\bar{\mathcal{X}}(x, \alpha)$ .

**Lemma 3.3.** Let  $u = \sum_{i=1}^N \lambda_i u_i^*$ , where  $u_i^* \in \mathbb{U}$ ,  $\Pi(u_i^*) \neq \emptyset$  and  $\lambda_i \geq 0$  for all  $i \in \mathbb{N}_{[1, N]}$  with  $\sum_{i=1}^N \lambda_i = 1$ . Then

$$\bigoplus_{i=1}^N \lambda_i \Pi(u_i^*) \subseteq \Pi(u). \quad (11)$$

**Proof.** The convexity of  $\mathbb{U}$  implies that  $u = \sum_{i=1}^N \lambda_i u_i^* \in \mathbb{U}$ , while the convexity of  $\mathbb{Q}$  and  $\mathbb{Q} \ominus \mathbb{W}$  imply that  $x \in \mathbb{Q}$  and  $Ax + Bu \in \mathbb{Q} \ominus \mathbb{W}$  if  $x = \sum_{i=1}^N \lambda_i x_i^*$ , for any  $\{x_i^*\}_{i=1}^N$  such that  $x_i^* \in \Pi(u_i^*) \forall i \in \mathbb{N}_{[1, N]}$ . We therefore have  $x \in \Pi(u)$  and hence (11) holds.  $\square$

**Lemma 3.4.** Let  $x = \sum_{i=1}^N \lambda_i x_i^*$ , where  $x_i^* \in \mathbb{Q}$  and  $\lambda_i \geq 0$  for all  $i \in \mathbb{N}_{[1, N]}$  with  $\sum_{i=1}^N \lambda_i = 1$ , and let  $\alpha_i \in [0, 1]$  for all  $i \in \mathbb{N}_{[1, N]}$ . Then

$$\bar{\mathcal{X}}(x, \min_{i \in \mathbb{N}_{[1, N]}} \alpha_i) \subseteq \bigoplus_{i=1}^N \lambda_i \bar{\mathcal{X}}(x_i^*, \alpha_i) \subseteq \bar{\mathcal{X}}(x, \max_{i \in \mathbb{N}_{[1, N]}} \alpha_i). \quad (12)$$

**Proof.** Given the assumptions on  $x_i^*$ ,  $\lambda_i$  and  $\alpha_i$ , we have  $\bar{\mathcal{X}}(x_i^*, \alpha_i) \supseteq \bar{\mathcal{X}}(x_i^*, \min_{i \in \mathbb{N}_{[1, N]}} \alpha_i)$ ,  $\forall i \in \mathbb{N}_{[1, N]}$ , and hence

$$\bigoplus_{i=1}^N \lambda_i \bar{\mathcal{X}}(x_i^*, \alpha_i) \supseteq \bigoplus_{i=1}^N \lambda_i \bar{\mathcal{X}}(x_i^*, \min_{i \in \mathbb{N}_{[1, N]}} \alpha_i)$$

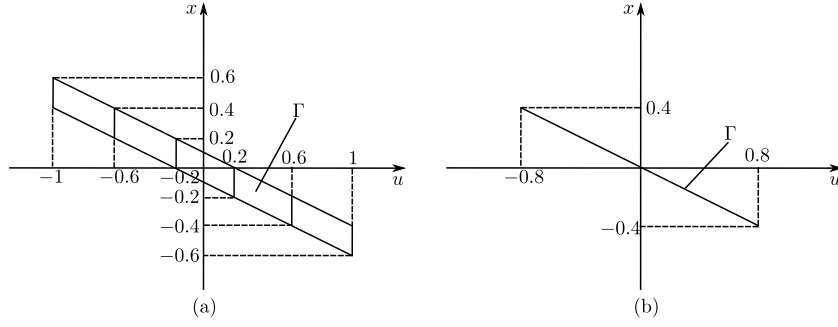

Fig. 2. The set  $\Gamma$  for two different RCISs: (a)  $\mathbb{Q} = [-0.6, 0.6]$ ; (b)  $\mathbb{Q}' = [-0.4, 0.4]$ .

$$\begin{aligned} &= \{(1 - \min_{i \in \mathbb{N}_{[1,N]}} \alpha_i)x\} \oplus \min_{i \in \mathbb{N}_{[1,N]}} \alpha_i \mathbb{Q} \\ &= \bar{\mathcal{X}}(x, \min_{i \in \mathbb{N}_{[1,N]}} \alpha_i). \end{aligned}$$

This proves the first subset relation in (12); the second can be proved using a similar argument.  $\square$

We define the critical vertices of  $\Gamma$  as follows.

**Definition 3.1.** A vertex  $(x, u)$  of  $\Gamma$  is said to be a *critical vertex* of  $\Gamma$  if: (i)  $x \in \text{vert}(\mathbb{Q})$ , (ii)  $\bar{\mathcal{X}}(x, \alpha) \subseteq \Pi(u)$  for some  $\alpha \in (0, 1]$ .

The main result of this section (Theorem 3.2) states that an invariant cover  $(\mathcal{A}, G)$  exists for the system (1) and the set  $\mathbb{Q}$  if and only if every  $x \in \text{vert}(\mathbb{Q})$  corresponds to a critical vertex of  $\Gamma$ . We prove this using Lemmas 3.3, 3.4, and the properties of critical vertices to define for each  $x \in \mathbb{Q}$  a control  $u$  such that  $\bar{\mathcal{X}}(x, \alpha) \subseteq \Pi(u)$  for some  $\alpha > 0$ . However, as  $x$  approaches the boundary of  $\mathbb{Q}$ ,  $x$  also approaches the boundary of  $\bar{\mathcal{X}}(x, \alpha)$ . To ensure the existence of  $r > 0$  such that  $\mathbb{B}_r(x) \cap \mathbb{Q} \subseteq \Pi(u)$  for all  $x \in \mathbb{Q}$  and thus fulfill the conditions of Theorem 3.1, we therefore consider the set  $\bar{\mathcal{X}}(y_\sigma(x), \alpha)$ . For  $\sigma \in (0, 1)$  and  $x \in \mathbb{Q} \setminus (1 - \sigma)\mathbb{Q}$ ,  $y_\sigma(x)$  is defined as a point in the boundary of  $\mathbb{Q}$  given by the solution of a linear program (LP)

$$\begin{aligned} y_\sigma(x) &= \arg \max_{y \in \mathbb{Q}} \min_{i \notin J_\sigma(x)} \sigma [q]_i - [Q]_i (x - (1 - \sigma)y) \\ \text{s.t.} \quad & [Q]_j y = [q]_j \quad \forall j \in J_\sigma(x) \end{aligned} \quad (13)$$

with  $J_\sigma(x) = \{j \in \mathbb{N}_{[1,n_q]} \mid [Q]_j x > (1 - \sigma)[q]_j\}$ . For  $x \in (1 - \sigma)\mathbb{Q}$ , we define  $y_\sigma(x)$  by

$$y_\sigma(x) = x. \quad (14)$$

An upper limit on  $\sigma$  is provided by the following result.

**Lemma 3.5.** Let  $\sigma \in (0, \bar{\sigma}]$ , where

$$\bar{\sigma} = \frac{\min_{k \in \mathbb{N}_{[1,n_q]}} \min_{x \in \text{vert}(\mathbb{Q})} [q]_k - [Q]_k x}{\max_{k \in \mathbb{N}_{[1,n_q]}} \max_{x \in \mathbb{Q}} [q]_k - [Q]_k x},$$

then

- (i).  $y_\sigma(x)$  exists for all  $x \in \mathbb{Q}$ ;
- (ii).  $\mathbb{B}_r(x) \cap \mathbb{Q} \subseteq \bar{\mathcal{X}}(y_\sigma(x), \sigma)$  if  $r = \sigma^2 \min_{j \in \mathbb{N}_{[1,n_q]}} [q]_j$ .

**Proof.** See Appendix.

**Theorem 3.2.** There exists an invariant cover  $(\mathcal{A}, G)$  of the system (1) and the set  $\mathbb{Q}$  if and only if each vertex  $x$  of  $\mathbb{Q}$  corresponds to a critical vertex  $(x, u)$  of  $\Gamma$ .

**Proof.** See Appendix.

Theorem 3.2 shows that it can be determined whether or not an invariant cover exists by checking if each vertex of  $\mathbb{Q}$

has a corresponding critical vertex of  $\Gamma$ . This is the basis of the computational procedure described in Section 5.

**Example 3.1.** The set  $\Gamma$  is shown in Fig. 2(a) for the system in Example 2.1 with  $\mathbb{Q} = [-0.6, 0.6]$  being an RCIS. It can be seen that the vertices  $x = -0.6$  and  $x = 0.6$  of  $\mathbb{Q}$  correspond respectively to critical vertices  $(-0.6, 1)$  and  $(0.6, -1)$  of  $\Gamma$ . In particular, it is easy to verify that  $\alpha = 1/6$  gives  $\bar{\mathcal{X}}(-0.6, 1/6) = \Pi(1) = [-0.6, -0.4]$  and  $\bar{\mathcal{X}}(0.6, 1/6) = \Pi(-1) = [0.4, 0.6]$ . Theorem 3.2 therefore implies that an invariant cover of  $\mathbb{Q}$  exists, which was given in Example 2.1 and is shown in Fig. 2(a).

Consider the set  $\mathbb{Q}' = [-0.4, 0.4]$ , which is also an RCIS. The corresponding set  $\Gamma$  for  $\mathbb{Q}'$  is shown in Fig. 2(b). In this case the set  $\Gamma$  is a line segment. Therefore the vertices of  $\mathbb{Q}'$  have no corresponding critical vertices of  $\Gamma$ . In particular, there is no finite set of control inputs such that (9) holds and thus there does not exist an invariant cover for this scalar system and the set  $\mathbb{Q}'$ .

It can be determined whether or not a given vertex of  $\mathbb{Q}$  corresponds to a critical vertex of  $\Gamma$  by solving a linear program, as we show next. Given the vertices of  $\mathbb{Q}$ , this suggests a computationally tractable method for checking whether or not an invariant cover exists: solve the LP for each vertex  $x \in \text{vert}(\mathbb{Q})$ .

**Lemma 3.6.** Let  $\alpha^*(x)$  be the optimal value of the LP

$$\begin{aligned} \alpha^*(x) &= \max_{\alpha \in [0, 1], S \geq 0, u} \alpha \\ & (1 - \alpha)PAx + Sq + PBu \leq p \\ \text{s.t.} \quad & F_u u \leq f_u \\ & SQ = \alpha PA \end{aligned} \quad (15)$$

and  $u^*(x)$  be the solution set for  $u$ . Then  $(x, u)$  is a critical vertex of  $\Gamma$  if and only if  $\alpha^*(x) > 0$ ,  $x \in \text{vert}(\mathbb{Q})$ , and  $u \in u^*(x)$ .

**Proof.** See Appendix.

#### 4. Bounds on the minimal cardinality of an invariant cover

This section develops an approach based on the existence condition of Theorem 3.2 to address Problem 2.2. We derive upper and lower bounds on  $|\mathcal{A}|^*$ , the minimal cardinality of an invariant cover  $(\mathcal{A}, G)$  of the system (1) and the set  $\mathbb{Q}$ .

Define

$$v^* = \max_{u \in \Phi} \text{vol}(\Pi(u)),$$

where  $\Phi = \{u \in \mathbb{U} \mid \exists x, (x, u) \in \Gamma\}$  and  $\text{vol}(\cdot)$  denotes the volume. Let  $\underline{\alpha}^*$  and  $\bar{\alpha}^*$  denote the optimal values

$$\begin{aligned} \underline{\alpha}^* &= \min_{x \in \text{vert}(\mathbb{Q})} \max_{\alpha \in [0, 1], S \geq 0, u} \alpha \\ & (1 - \alpha)PAx + Sq + PBu \leq p \\ \text{s.t.} \quad & F_u u \leq f_u \\ & SQ = \alpha PA \end{aligned} \quad (16)$$

and

$$\begin{aligned} \bar{\alpha}^* &= \max_{\alpha \in [0, 1], S \geq 0, y, u} \alpha \\ &\text{s.t.} \quad Qy \leq (1 - \alpha)q \\ &\quad PAy + Sq + PBu \leq p \\ &\quad F_u u \leq f_u \\ &\quad SQ = \alpha PA. \end{aligned} \tag{17}$$

**Remark 4.1.** In (17),  $\bar{\alpha}^*$  is the solution of a single LP, whereas  $\underline{\alpha}^*$  in (16) is computed by solving one LP for each vertex of  $\mathbb{Q}$ . In particular,  $\underline{\alpha}^* = \min_{x \in \text{vert}(\mathbb{Q})} \alpha^*(x)$ , where  $\alpha^*(x)$  is given by (15).

Before giving the bounds on  $|\mathcal{A}|^*$ , we need the following lemma.

**Lemma 4.1.** Let  $\delta \subseteq \mathbb{Q}$  and  $\sigma = \min\{\underline{\alpha}^*, \bar{\sigma}\}$ . Then,

- (i).  $(\{x\} \oplus \sigma\delta) \subseteq \bar{\mathcal{X}}((1 - \sigma)^{-1}x, \sigma)$  for  $x \in (1 - \sigma)\mathbb{Q}$ ;
- (ii).  $(\{x\} \oplus \sigma^2\delta) \cap \mathbb{Q} \subseteq \bar{\mathcal{X}}(y_\sigma(x), \sigma)$  for  $x \in \mathbb{Q} \setminus (1 - \sigma)\mathbb{Q}$ ,

where  $y_\sigma(x)$  is defined in (13).

**Proof.** See Appendix.

**Theorem 4.1.** Let  $\delta = [\underline{d}_1, \bar{d}_1] \times \dots \times [\underline{d}_{n_x}, \bar{d}_{n_x}]$  and  $\Delta = [\underline{D}_1, \bar{D}_1] \times \dots \times [\underline{D}_{n_x}, \bar{D}_{n_x}]$  be inner- and outer-bounding hyperrectangles such that  $\delta \subseteq \mathbb{Q} \subseteq \Delta$ , and let  $\sigma = \min\{\underline{\alpha}^*, \bar{\sigma}\}$ . Then  $|\mathcal{A}|^*$  satisfies

$$\begin{aligned} (a). \quad \left\lceil \frac{\text{vol}(\mathbb{Q})}{v^*} \right\rceil &\leq |\mathcal{A}|^* \leq \prod_{i=1}^{n_x} \left\lceil \frac{\bar{D}_i - \underline{D}_i}{(\bar{d}_i - \underline{d}_i)\sigma^2} \right\rceil \\ (b). \quad |\mathcal{A}|^* &= 1 \text{ if and only if } \bar{\alpha}^* = 1. \end{aligned} \tag{18}$$

**Proof.** See Appendix.

**Remark 4.2.** We note that Tomar et al. (2020) only provides a lower bound on the invariance feedback entropy and the minimal data rate necessary for invariance. As a complement, the upper bound in (18) on the minimal cardinality of an invariant cover also provides a bound on these quantities in the light of Lemma 3 of Tomar et al. (2020). Note that this upper bound is likely to be loose due to the appearance of  $\sigma^2$  in the denominator, and this is observed in numerical examples. In addition, the lower bound in (18) is valid for the minimal data rate achieved over all admissible static coder–controllers, but differs from its lower bound in Theorem 8 of Tomar et al. (2020).

The lower bound on  $|\mathcal{A}|^*$  in (18) can in principle be computed by determining  $\text{vol}(\Pi(u))$  over a finite set of points. Specifically, the vertices of  $\Pi(u)$  are obtained (as functions of  $u \in \Phi$ ) as the solutions of a set of right-hand-side multiparametric linear programs, and they are therefore piecewise affine functions of  $u$  with the pieces defined by a polyhedral complex,  $\mathcal{K}$ , of subsets of  $\Phi$  (Gal, 1995). As a result, the volume of  $\Pi(u)$  can be expressed (by triangulating  $\Pi(u)$  into a collection of simplexes (Henk, Richter-Gebert, & Ziegler, 2017)) as a sum of non-negative determinants of matrices whose elements are piecewise affine functions of  $u$ . It follows that  $\text{vol}(\Pi(u))$  is piecewise quasi-convex in  $u$  and the maximum,  $v^*$ , over  $u \in \Phi$ , is therefore achieved at a vertex of the complex  $\mathcal{K}$ .

Determining the volume of an arbitrary polytopic set is computationally hard, see Schneider (2014). Since  $\bar{\alpha}^*$  in (17) is the maximum value of  $\alpha$  such that  $\bar{\mathcal{X}}(x, \alpha) \subseteq \Pi(u)$  for some  $x \in \mathbb{Q}$  and  $u \in \mathbb{U}$ , a convenient approximation is

$$v^* \approx (\bar{\alpha}^*)^{n_x} \text{vol}(\mathbb{Q}).$$

This implies that the lower bound on  $|\mathcal{A}|^*$  in (18) is approximately equal to  $(1/\bar{\alpha}^*)^{n_x}$ . We note however that  $(1/\bar{\alpha}^*)^{n_x}$  does not necessarily lower-bound  $|\mathcal{A}|^*$  since  $v^* \geq (\bar{\alpha}^*)^{n_x} \text{vol}(\mathbb{Q})$ .

**Remark 4.3.** Consider a scalar system:

$$x_{k+1} = ax_k + u_k + w_k,$$

with  $\mathbb{X} = \mathbb{R}$ ,  $\mathbb{U} = [\underline{u}, \bar{u}]$ , and  $\mathbb{W} = [\underline{w}, \bar{w}]$ . Let  $\mathbb{Q} = [q, \bar{q}]$ . Assume that  $q < \underline{w} < \bar{w} < \bar{q}$ . Then, we have that  $\text{vert}(\mathbb{Q}) = \{q, \bar{q}\}$  and  $\mathbb{Q} \ominus \bar{\mathbb{W}} = [q - \bar{w}, \bar{q} - \bar{w}]$ .

Recall  $\underline{\alpha}^*$  and  $\bar{\alpha}^*$  defined in Eqs. (16)–(17). Since  $v^* = (\bar{\alpha}^*)^{n_x} \text{vol}(\mathbb{Q})$  when  $n_x = 1$ , the lower bound in (18) becomes  $\lceil \frac{1}{\bar{\alpha}^*} \rceil \leq |\mathcal{A}|^*$ . On the other hand, according to the definitions of  $\bar{\mathcal{X}}(x, \alpha)$  and  $\underline{\alpha}^*$ , we have that  $\bar{\mathcal{X}}(x, \underline{\alpha}^*) \subseteq \bar{\mathcal{X}}(x, \alpha) \subseteq \mathbb{Q}$ ,  $\forall \alpha \in [\underline{\alpha}^*, 1]$ . Since  $n_x = 1$ , one can find an invariant cover of  $\mathbb{Q}$  of the form  $\cup_{i=1}^N \bar{\mathcal{X}}(x_i, \underline{\alpha}^*)$  for some  $N \in \mathbb{N}$ . Thus, due to the fact that  $\text{vol}(\bar{\mathcal{X}}(x_i, \underline{\alpha}^*)) = \underline{\alpha}^* \text{vol}(\mathbb{Q})$ , an upper bound on  $|\mathcal{A}|^*$  is  $|\mathcal{A}|^* \leq \lceil \frac{1}{\underline{\alpha}^*} \rceil$ .

Denote by  $\alpha^*(q)$  and  $\alpha^*(\bar{q})$  the optimal value of LP (15) for the vertices of  $\mathbb{Q}$ , respectively. Since the optimal value occurs at a vertex of the feasible region for the LP, we have  $\underline{\alpha}^* \in \{\alpha^*(q), \alpha^*(\bar{q})\}$  and  $\bar{\alpha}^* \in \{\alpha^*(q), \alpha^*(\bar{q})\}$ . Therefore, for the scalar case, the bounds  $\lceil \frac{1}{\bar{\alpha}^*} \rceil \leq |\mathcal{A}|^* \leq \lceil \frac{1}{\underline{\alpha}^*} \rceil$  are tight if and only if  $\alpha^*(q) = \alpha^*(\bar{q})$ .

In the case of a symmetric scalar system, we set  $0 < -\underline{u} = \bar{u}$ ,  $0 < -\underline{w} = \bar{w}$ , and  $0 < -q = \bar{q}$ . Without loss of generality, we assume that  $a > 0$ . In this case,  $\alpha^*(q) = \alpha^*(\bar{q})$  holds. The explicit minimal cardinality of an invariant cover is then

$$|\mathcal{A}|^* = \begin{cases} \lceil \frac{a\bar{q}}{\bar{q}-\bar{w}} \rceil & \text{if } (a-1)\bar{q} + \bar{w} + \bar{u} \geq 0 \\ +\infty & \text{otherwise.} \end{cases}$$

This can be validated by Example 3.1. Note that, in contrast to Tomar et al. (2020), the control limits are taken into account in this analysis.

## 5. Algorithm to compute an invariant cover

This section uses the existence conditions discussed in Section 3 to solve Problem 2.3. Algorithm 1 describes a procedure for computing an invariant cover of system (1) and a given polytopic set  $\mathbb{Q}$ . The algorithm makes use of the following result (see Bemporad, Morari, Dua, & Pistikopoulos, 2002, Theorem 3).

**Lemma 5.1.** Let  $\bar{\mathbb{Y}}$  be a polytope and let  $\mathbb{Y}_0 = \{z \in \bar{\mathbb{Y}} \mid Yz \leq y\}$  be a nonempty polytopic subset of  $\bar{\mathbb{Y}}$  with  $y \in \mathbb{R}^{n_y}$ . Let  $\mathbb{Y}_i = \{z \in \bar{\mathbb{Y}} \mid [Y]_i z \geq [y]_i, [Y]_j z \leq [y]_j \forall j < i\}$  for each  $i \in \mathbb{N}_{[1, n_y]}$ . Then,  $\cup_{i=0}^{n_y} \mathbb{Y}_i = \bar{\mathbb{Y}}$ ,  $\text{int}(\mathbb{Y}_i) \cap \text{int}(\mathbb{Y}_0) = \emptyset$ ,  $\forall i$ , and  $\text{int}(\mathbb{Y}_i) \cap \text{int}(\mathbb{Y}_j) = \emptyset$ ,  $\forall i \neq j$ . That is,  $\{\mathbb{Y}_i\}_{i=1}^{n_y}$  is a partition of  $\bar{\mathbb{Y}}$  with respect to  $\mathbb{Y}_0$ .

Algorithm 1 first uses the condition in Theorem 3.2 to check the existence of an invariant cover (lines 1–9). If no invariant cover exists, the algorithm stops and returns Null. Otherwise, the algorithm continues by repeatedly partitioning subsets of  $\mathbb{Q}$  using Lemma 5.1, with the initial subset  $\mathbb{Y}_0$  defined in terms of a set  $\Pi(u)$  constructed using a convex combination of the vertices of  $\mathbb{Q}$ . The procedure PARTITION( $\bar{\mathbb{Y}}$ ) (lines 12–23) constructs a cover of the set  $\bar{\mathbb{Y}}$  and stores this cover and the corresponding control inputs in  $(\mathcal{A}, G)$ . This process continues until the elements of  $\mathcal{A}$  cover the entire set  $\mathbb{Q}$ .

A vertex of  $\bar{\mathbb{Y}}$  in line 13 can be found by checking whether any vertex of  $\mathbb{Q}$  lies in  $\bar{\mathbb{Y}}$  and then solving a LP in  $n_x$  variables if this

**Algorithm 1** Invariant Cover Computation

**Input:** System (1), and sets  $\mathbb{Q}$ ,  $\mathbb{U}$ , and  $\mathbb{Q} \ominus \mathbb{W}$ .  
**Output:** An invariant cover  $(\mathcal{A}, \mathcal{G})$  for (1) and  $\mathbb{Q}$ .  
1:  $\{x_i^v\}_{i=1}^N \leftarrow \text{vert}(\mathbb{Q})$   
2: **for all**  $i \in \mathbb{N}_{[1,N]}$  **do**  
3:   Solve (15) for  $\alpha^*(x_i^v)$   
4:    $u_i^v \leftarrow u^*(x_i^v)$   
5: **end for**  
6:  $\underline{\alpha}^* \leftarrow \min_i \alpha^*(x_i^v)$   
7: **if**  $\underline{\alpha}^* = 0$  **then**  
8:   Stop and return Null  
9: **end if**  
10:  $\sigma \leftarrow \min\{\underline{\alpha}^*, \bar{\sigma}\}$  and  $\mathcal{A} \leftarrow \emptyset$   
11: Execute PARTITION( $\mathbb{Q}$ )  
12: **procedure** PARTITION( $\tilde{\mathbb{Y}}$ )  
13:   Compute  $x \in \text{vert}(\tilde{\mathbb{Y}})$   
14:   Compute  $y_\sigma(x)$  using (13)–(14)  
15:   Compute  $\{\lambda_i\}_{i=1}^N$  satisfying  $y_\sigma(x) = \sum_{i=1}^N \lambda_i x_i^v$ ,  $\sum_{i=1}^N \lambda_i = 1$   
    and  $\lambda_i \geq 0 \forall i \in \mathbb{N}_{[1,N]}$   
16:    $u \leftarrow \sum_{i=1}^N \lambda_i u_i^v$   
17:    $\mathcal{A} \leftarrow \{\mathcal{A}, \Pi(u)\}$  and  $G(\Pi(u)) \leftarrow u$   
18:    $\mathbb{Y}_0 \leftarrow \tilde{\mathbb{Y}} \cap \Pi(u)$   
19:   Partition  $\tilde{\mathbb{Y}} \setminus \mathbb{Y}_0$  into  $\{\mathbb{Y}_i\}_{i=1}^{n_y}$  using Lemma 5.1  
20:   **for each** nonempty sub-region  $\mathbb{Y}_i$  **do**  
21:     Execute PARTITION( $\mathbb{Y}_i$ )  
22:   **end for**  
23: **end procedure**  
24: **Return:**  $(\mathcal{A}, G)$

check fails. The set  $\{\lambda_i\}_{i=1}^N$  in line 15 can be defined uniquely as the solution of a LP in  $N$  variables:

$$\min_{\lambda_1, \dots, \lambda_N} \left\| \sum_{i=1}^N \lambda_i u_i^v \right\|_\infty$$

$$\text{s.t. } y = \sum_{i=1}^N \lambda_i x_i^v, \quad \sum_{i=1}^N \lambda_i = 1, \quad \lambda_i \geq 0, \quad \forall i \in \mathbb{N}_{[1,N]}$$

The main computational effort of the Algorithm is spent on solving the LPs in lines 13–15.

**Theorem 5.1.** Algorithm 1 finds an invariant cover of the system (1) and the set  $\mathbb{Q}$  in finite time if it exists.

**Proof.** See Appendix.

**Remark 5.1.** In contrast to methods for determining robust invariant sets by iteratively computing robust backward reachable sets until convergence (e.g., Rungger & Tabuada, 2017), Algorithm 1 computes an invariant cover by repeatedly partitioning an unexplored region.

**Remark 5.2.** In common with other piecewise affine control laws (e.g., Bemporad et al., 2002), the online implementation of a static coder–controller based on an invariant cover  $(\mathcal{A}, G)$  may be computationally expensive for high-dimensional systems. However, we can evaluate and may reduce the online computational complexity in the following way. Note that the invariant cover computed by Algorithm 1 has the property that each element of  $\mathcal{A}$  is a polytope  $\Pi(u)$ ,  $u \in \mathcal{U}$ , defined by the intersection of at most  $n_p + n_q$  half-spaces. As a result, the coder–controller can be computed for any state  $x \in \mathbb{Q}$  in time that scales as  $O((n_p + n_q) \log_2 N)$  where  $N = |\mathcal{A}|$ . To see this, let  $\mathcal{A} = \bigcup_{i=1}^N \Pi(u_i)$  and  $\Pi(u_i) = \{x \in \mathbb{R}^{n_x} \mid H_x x + H_u u \leq h\}$ , where  $h \in \mathbb{R}^{n_h}$  with

$n_h \leq n_p + n_q$ , and suppose that, for each  $j \in \mathbb{N}_{[1, n_h]}$ , the set  $\{[H_u]_j u_i, i \in \mathbb{N}_{[1, N]}\}$  is sorted (e.g., in increasing order) offline. Online, given the state  $x$ , we can determine a set  $\mathcal{I}_{n_h}$  such that  $x \in \Pi(u_i)$  for all  $i \in \mathcal{I}_{n_h}$  by setting  $\mathcal{I}_0 = \mathbb{N}_{[1, N]}$  and computing  $\mathcal{I}_j = \mathcal{I}_{j-1} \cap \{i \in \mathbb{N}_{[1, N]} \mid [H_x]_j x \leq [h]_j\}$  for  $j = 1, \dots, n_h$ . Since sorting is done offline, the online computation of  $\mathcal{I}_j$  can be performed by a binary search requiring fewer than  $O(\log_2 N)$  comparisons for each  $j = 1, \dots, n_h$ . The control law can then be obtained by selecting  $u \in \{u_i, i \in \mathcal{I}_{n_h}\}$ .

**6. Numerical examples**

This section illustrates the proposed algorithm and explores the dependence of computation on the system dimension. The numerical experiments were performed using Matlab R2018b with the lrs library (Avis, 2000) on a 2.9 GHz Intel Core i7 CPU with 16 GB RAM.

**6.1. Example 1**

Consider (1) with parameters defined by

$$A = \begin{bmatrix} 0.9225 & 1.0476 \\ 1.0476 & 0.9320 \end{bmatrix}, \quad B = \begin{bmatrix} 1.1518 & 0 \\ 2.4188 & 0.4991 \end{bmatrix},$$

$$F_u = \begin{bmatrix} 1 & 0 \\ 0 & 1 \\ -1 & 0 \\ 0 & -1 \end{bmatrix}, \quad f_u = \begin{bmatrix} 1 \\ 1 \\ 1 \\ 1 \end{bmatrix},$$

$$F_w = \begin{bmatrix} -0.9847 & 0.1745 \\ -0.4028 & -0.9153 \\ 0.2153 & -0.9766 \\ 0.6809 & -0.7324 \\ 0.4028 & 0.9153 \end{bmatrix}, \quad f_w = \begin{bmatrix} 0.1000 \\ 0.1000 \\ 0.1000 \\ 0.1000 \\ 0.1000 \end{bmatrix},$$

$$Q = \begin{bmatrix} -0.4040 & 0.9148 \\ 0.3521 & 0.9360 \\ -0.7061 & 0.7081 \\ 0.1622 & 0.9868 \\ 0.7061 & -0.7081 \\ -0.1622 & -0.9868 \end{bmatrix}, \quad q = \begin{bmatrix} 1.0572 \\ 1.0744 \\ 1.0704 \\ 1.0000 \\ 1.0000 \\ 1.0000 \end{bmatrix}.$$

By solving the optimization problem (16), we obtain  $\underline{\alpha}^* = 0.2813 > 0$ , which from Theorem 3.2 implies the existence of invariant cover.

First, we compare the bounds on the minimal cardinality of the invariant cover in Theorem 4.1 with that in Tomar et al. (2020). The lower bound on  $|\mathcal{A}|^*$  obtained by Theorem 8 of Tomar et al. (2020) is 1, while the lower bound from Theorem 4.1 is  $|\mathcal{A}|^* \geq 5$ . We can see that the lower bound in our paper is tighter than that in Tomar et al. (2020) in this example. One explanation is that the control set is taken into account when deriving the bounds in (18) by solving the LPs, while the lower bound in Theorem 8 of Tomar et al. (2020) is independent of the control set.

By implementing Algorithm 1, we compute the invariant cover  $(\mathcal{A}, G)$  with cardinality  $|\mathcal{A}| = 5$  for the set  $\mathbb{Q}$  shown in Fig. 3. We use this invariant cover to design a static coder–controller as in Tomar et al. (2020) and compute the state trajectory starting from a vertex of  $\mathbb{Q}$ , see Fig. 4(a). The state remains at all times inside the set  $\mathbb{Q}$ . The corresponding control input trajectory is shown in Fig. 4(b). The maximal data rate needed to guarantee invariance is no greater than  $\log_2 5$  bits per sampling interval. Note that the system in this example is open-loop unstable. From Section 1.2.2 of Lunze (2014), the critical data rate necessary for the stabilization of this system without disturbances is  $\log_2 1.9748$  bits per sampling interval, where 1.9748 is the unstable eigenvalue of the matrix  $A$ . This critical data rate is lower than  $\log_2 5$ , which is required for the robust invariance specification considered here.

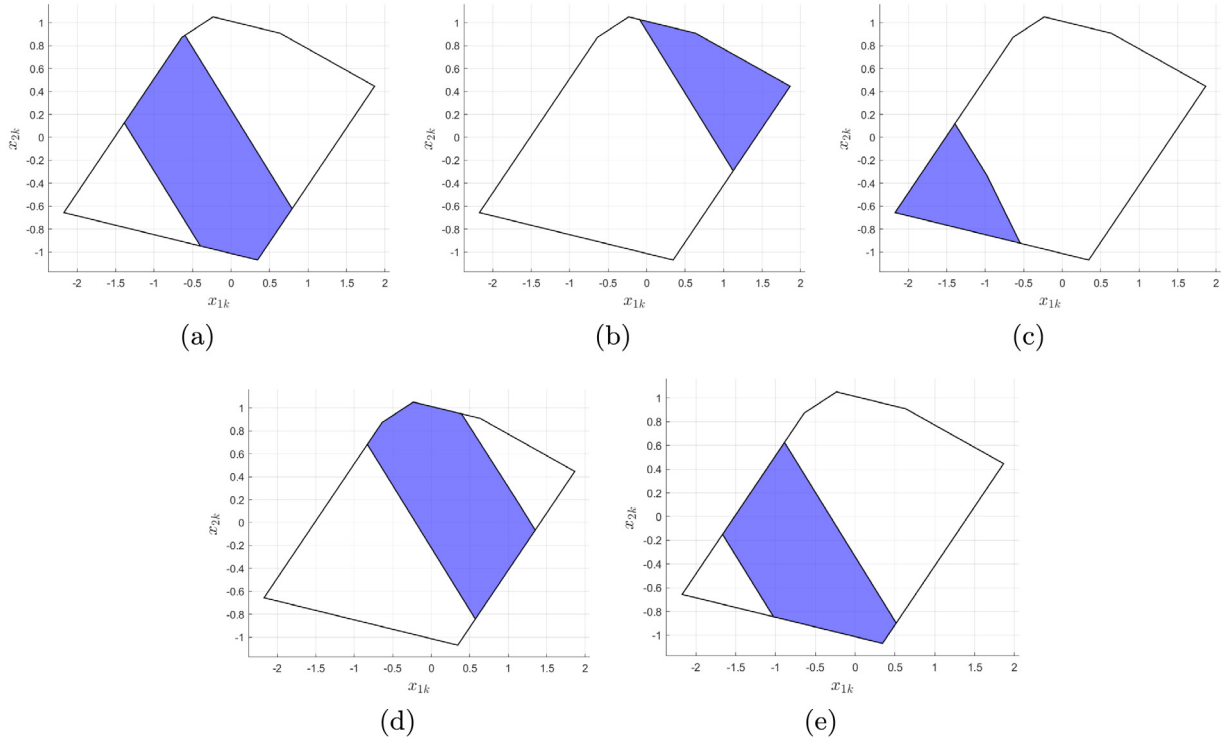

**Fig. 3.** Invariant cover  $(A, G)$  used in Example 1: (a)  $\mathbb{X}_1^{\text{ic}}$  and  $G(\mathbb{X}_1^{\text{ic}}) = [0.0461 \ 1]^T$ ; (b)  $\mathbb{X}_2^{\text{ic}}$  and  $G(\mathbb{X}_2^{\text{ic}}) = [-0.9317 \ 1]^T$ ; (c)  $\mathbb{X}_3^{\text{ic}}$  and  $G(\mathbb{X}_3^{\text{ic}}) = [0.9485 \ -0.0991]^T$ ; (d)  $\mathbb{X}_4^{\text{ic}}$  and  $G(\mathbb{X}_4^{\text{ic}}) = [-0.4455 \ 1]^T$ ; (e)  $\mathbb{X}_5^{\text{ic}}$  and  $G(\mathbb{X}_5^{\text{ic}}) = [0.3649 \ 0.6117]^T$ .

### 6.2. Example 2

We consider a quadrotor which is controlled by a remote computer via a communication network. Following Lai, Lan, and Chen (2019), the quadrotor can be modeled as a 6-DOF system. For each axis  $j \in \{x, y, z\}$ , the dynamics can be expressed as a 2-DOF discrete-time double integrator:

$$\mathbf{x}_{j,k+1} = A\mathbf{x}_{j,k} + B u_{j,k} + w_{j,k},$$

where

$$A = \begin{bmatrix} 1 & \tau \\ 0 & 1 \end{bmatrix}, B = \begin{bmatrix} \tau^2/2 \\ \tau \end{bmatrix},$$

the state  $\mathbf{x}_{j,k} = [p_{j,k} \ v_{j,k}]^T \in \mathbb{R}^2$  consists of the position and velocity, the control input  $u_{j,k} \in \mathbb{R}$  is the acceleration,  $w_{j,k}$  is the external disturbance, and  $\tau$  is the sampling period. The velocity and control input are subject to the constraints:  $v_{j,k} \in [v_{j,\min}, v_{j,\max}]$  and  $u_{j,k} \in [u_{j,\min}, u_{j,\max}]$ . The disturbance  $w_{j,k}$  is bounded according to  $\|w_{j,k}\|_\infty \leq \bar{w}_j$ .

The objective is to design a coder-controller with a finite data rate such that the quadrotor keeps moving in a safe region as shown in Fig. 6(a). We first compute the maximal RCIS  $\mathbb{Q}_j$  with respect to the safe region for each axis  $j$ . By following the results in this paper, we then compute an invariant cover through Algorithm 1 for each  $\mathbb{Q}_j$ . If the invariant cover exists for each axis, we can design a coder-controller similar to Example 1.

The constraints are defined by the following parameters:  $v_{j,\min} = -1 \text{ ms}^{-1}$ ,  $v_{j,\max} = 1 \text{ ms}^{-1}$ ,  $u_{j,\min} = -1 \text{ ms}^{-2}$ ,  $u_{j,\max} = 1 \text{ ms}^{-2}$ ,  $\bar{w}_j = 0.2$ , and the sampling interval is  $\tau = 0.5 \text{ s}$ . The computed RCIS for each axis is shown in Fig. 5. The lower bound for each axis from Theorem 4.1 is  $|\mathcal{A}_j|^* \geq 3$ . Note that the origin is not in the interior of the sets  $\mathbb{Q}_j$ . We need to transform the system such that the sets  $\mathbb{Q}_j$  contain the origin before using Algorithm 1. We compute an invariant cover  $(A_j, G_j)$  for each  $\mathbb{Q}_j$  with cardinality

$|\mathcal{A}_j| = 5$ , as shown in Fig. 5. The corresponding static coder-controller ensures that the quadrotor position remains in the safe region at all times and the velocity and acceleration satisfy their constraints. See Fig. 6 for the position and velocity trajectories and Fig. 7 for the corresponding control inputs. Note that the control constraints are satisfied. The data rate needed to enforce the invariance is at most  $3 \log_2 5 \approx 6.9658 \text{ bits/s}$ .

### 6.3. Computation time and invariant cover cardinality

To investigate how the computation required by Algorithm 1 depends on the state dimension  $n_x$  and control dimension  $n_u$ , we consider a range of values for  $(n_x, n_u)$  and for each case we generate 100 random systems in the form of (1) with linear state and control constraints, and with spectral radii no greater than 1.3. For each realization we find a set  $\mathbb{Q}$  that admits an invariant cover and use Algorithm 1 to compute an invariant cover. The dependence of computation time on  $(n_x, n_u)$  is shown in the boxplot of Fig. 8. As expected, the computation time increases as the state and control input dimensions increase.

Fig. 9 compares  $|\mathcal{A}|$ , i.e., the cardinality of  $\mathcal{A}$  computed by Algorithm 1, with the lower bound derived in Section 4 on the minimal cardinality  $|\mathcal{A}|^*$  for the same randomly generated systems. The results shown (with  $1 \leq |\mathcal{A}| \leq 50$ ) represent 83% of system realizations. Although Algorithm 1 is not guaranteed to find an invariant cover with minimal cardinality,  $|\mathcal{A}|$  (shown by the dashed line in Fig. 9) does not exceed the upper bound on  $|\mathcal{A}|^*$  in all cases.

## 7. Conclusion

This paper considers some fundamental problems concerning the invariant cover for uncertain discrete-time linear control systems. We provide computationally tractable necessary and

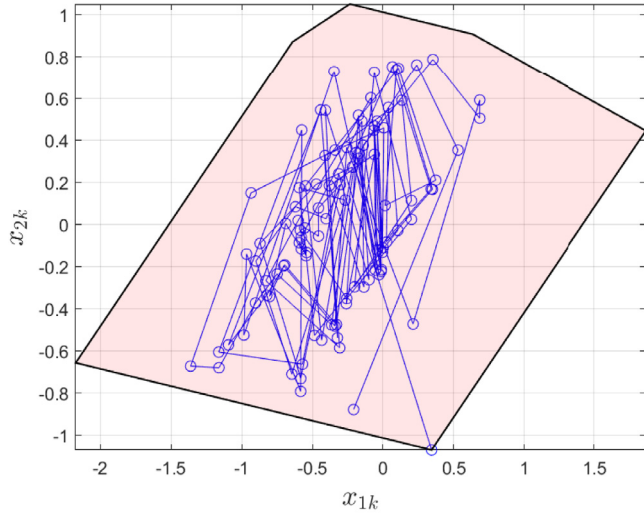

(a)

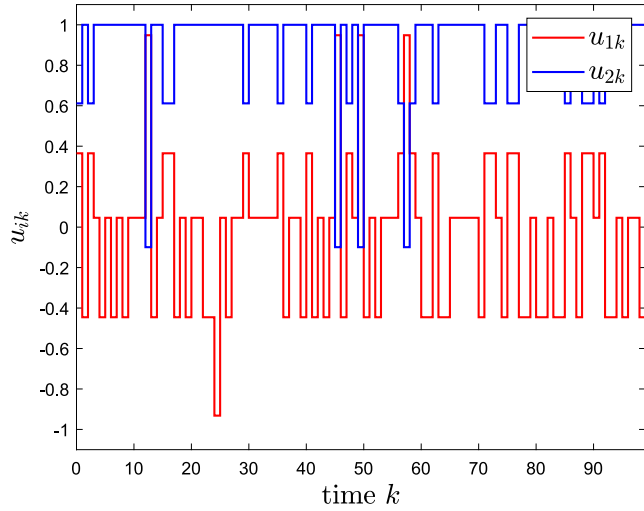

(b)

Fig. 4. (a) State trajectory; (b) Control input trajectory.

sufficient conditions on the existence of an invariant cover, as well as upper and lower bounds on the minimal cardinality of the invariant cover. In addition, we give an algorithm to compute an invariant cover in finite time, whenever it exists. Numerical examples are given to illustrate the effectiveness of the results.

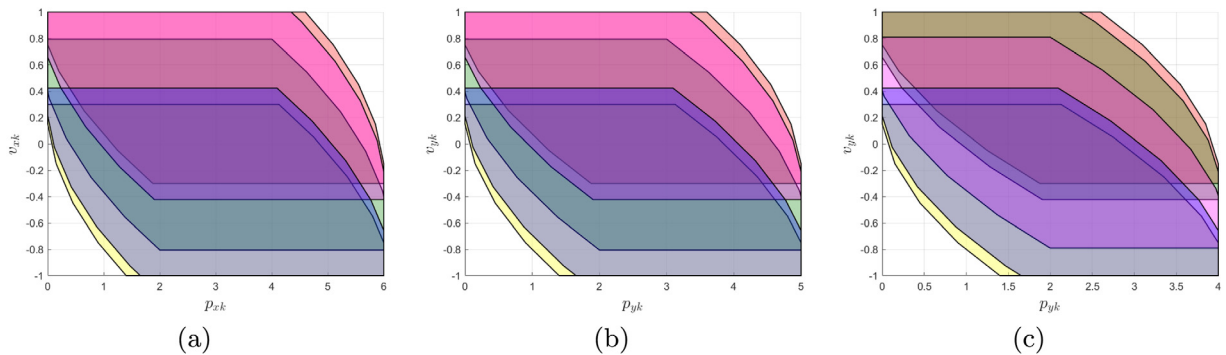

(a)

(b)

(c)

Fig. 5. (a) RCIS  $\mathbb{Q}_x$  and invariant cover for  $x$  axis; (b) RCIS  $\mathbb{Q}_y$  and invariant cover for  $y$  axis; (c) RCIS  $\mathbb{Q}_z$  and invariant cover for  $z$  axis. Here, the elements in the invariant covers are in different colors. (For interpretation of the references to color in this figure legend, the reader is referred to the web version of this article.)

Future studies include tighter upper bounds on the minimal cardinality of the invariance cover, abstractions of high-dimensional spaces from complex specifications, and application to safety-critical systems.

**Appendix. Proofs**

**Proof of Lemma 3.2.** The sufficiency directly follows from Definition 2.2 and Lemma 3.1. We prove the necessity as follows. Let  $(\mathcal{A}, G)$  be an invariant cover for (1) and  $\mathbb{Q}$ , where  $\mathcal{A} = \{\mathbb{X}_i^{ic}\}_{i=1}^{N_{ic}}$  and for each  $\mathbb{X}_i^{ic}$ , there exists  $u_i^{ic} = G(\mathbb{X}_i^{ic}) \in \mathbb{U}$  such that  $A\mathbb{X}_i^{ic} \oplus Bu_i^{ic} \subseteq \mathbb{Q} \ominus \mathbb{W}$ . Here  $N_{ic}$  is the cardinality of  $\mathcal{A}$ .

From the definition of  $\Pi(u)$  in (8), it follows that any set  $\mathbb{Y} \subseteq \mathbb{Q}$  such that  $A\mathbb{Y} \oplus \{Bu\} \subseteq \mathbb{Q} \ominus \mathbb{W}$  for some  $u \in \mathbb{U}$  is a subset of  $\Pi(u)$ . This implies that,  $\forall i \in \mathbb{N}_{[1, N_{ic}]}$ ,  $\mathbb{X}_i^{ic} \subseteq \Pi(u_i^{ic}) \subseteq \mathbb{Q}$ , and since  $\bigcup_{i=1}^{N_{ic}} \mathbb{X}_i^{ic} = \mathbb{Q}$ , it follows that  $\{u_i^{ic}\}_{i=1}^{N_{ic}}$  satisfies  $\bigcup_{i=1}^{N_{ic}} \Pi(u_i^{ic}) = \mathbb{Q}$ .  $\square$

**Proof of Theorem 3.1.** We first show that the existence of an invariant cover for (1) and  $\mathbb{Q}$  implies that for all  $x \in \mathbb{Q}$  there exist  $u \in \mathbb{U}$  and  $r > 0$  such that  $\mathbb{B}_r(x) \cap \mathbb{Q} \subseteq \Pi(u)$ .

For given  $x \in \mathbb{Q}$ ,  $u \in \mathbb{U}$  and  $r > 0$ , let  $\Theta(u)$  denote the set  $\{z \mid PAz + PBu \leq p\}$  and let  $\mathbb{P}_r(x)$  denote the set  $\{z \mid PA(z - x) \leq r\mathbf{1}\}$ . Furthermore, suppose that the rows of  $PA$  are normalized with  $\| [PA]_i \|_2 = 1, \forall i \in \mathbb{N}_{[1, n_p]}$  (this can be assumed without loss of generality by appropriately scaling  $P$  and  $p$ ). Then the  $n_x$ -dimensional ball  $\mathbb{B}_r(x)$  is a subset of  $\Theta(u)$  if and only if  $\mathbb{P}_r(x)$  is a subset of  $\Theta(u)$  (since the polytopes  $\Theta(u)$  and  $\mathbb{P}_r(x)$  share the same set of face normals and since each face of  $\mathbb{P}_r(x)$  is contained in a supporting hyperplane of  $\mathbb{B}_r(x)$ ). Moreover, from  $\Pi(u) = \Theta(u) \cap \mathbb{Q}$  it follows that  $\mathbb{B}_r(x) \cap \mathbb{Q} \subseteq \Pi(u)$  if  $\mathbb{P}_r(x) \cap \mathbb{Q} \subseteq \Pi(u)$ . But  $\mathbb{P}_r(x) \cap \mathbb{Q} \subseteq \Pi(u)$  requires that

$$\left\{ \begin{array}{l} z \mid PA(z - x) \leq r\mathbf{1} \\ Qz \leq q \end{array} \right\} \subseteq \left\{ \begin{array}{l} z \mid PAz + PBu \leq p \\ Qz \leq q \end{array} \right\},$$

and by linear programming duality this is equivalent to the condition that there exists a matrix  $S$  with non-negative elements such that

$$S \begin{bmatrix} PA \\ Q \end{bmatrix} = \begin{bmatrix} PA \\ Q \end{bmatrix}, \tag{19}$$

$$S \begin{bmatrix} r\mathbf{1} + PAx \\ q \end{bmatrix} \leq \begin{bmatrix} p - PBu \\ q \end{bmatrix}. \tag{20}$$

Replacing  $q$  on the left side of (20) with  $Qx + q - Qx$  and using (19), we re-write (20) as

$$\begin{bmatrix} PAx + PBu - p \\ Qx - q \end{bmatrix} \leq S \begin{bmatrix} -r\mathbf{1} \\ Qx - q \end{bmatrix}. \tag{21}$$



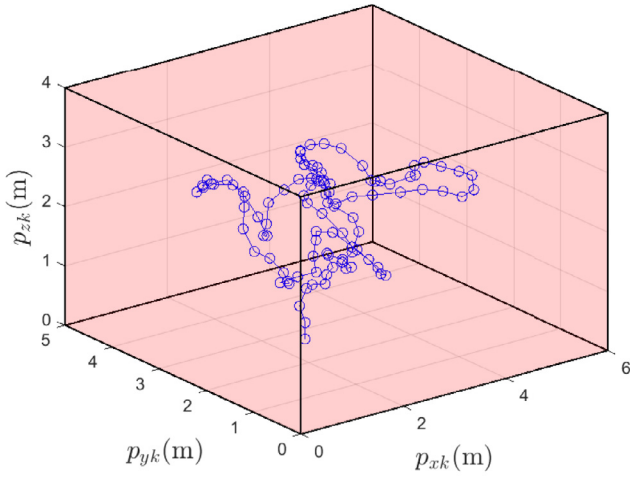

(a)

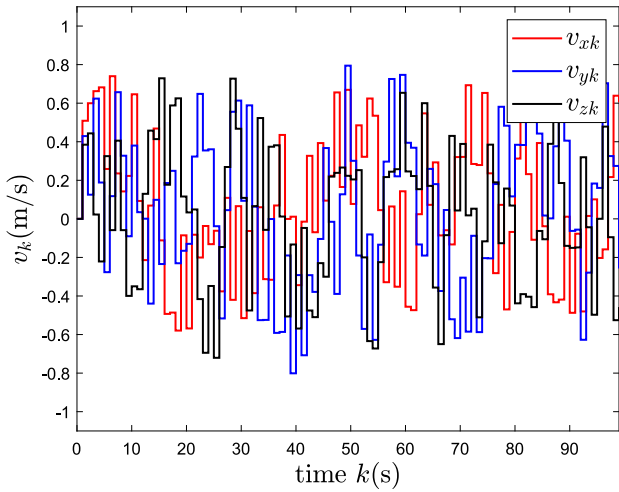

(b)

Fig. 6. (a) Position trajectory; (b) velocity trajectory.

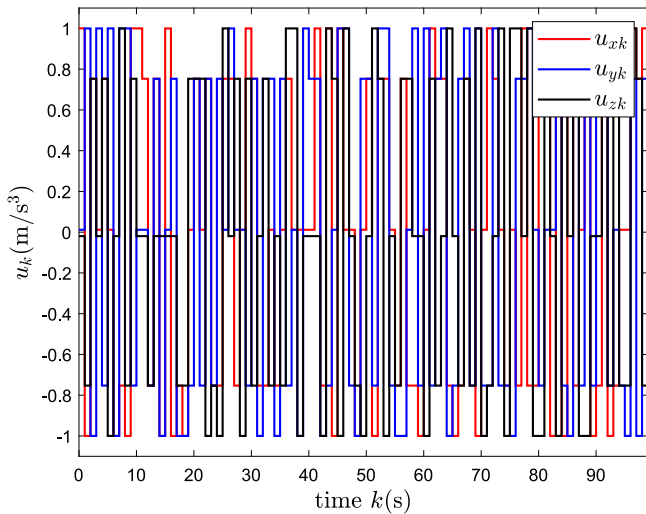

Fig. 7. Control input trajectory.

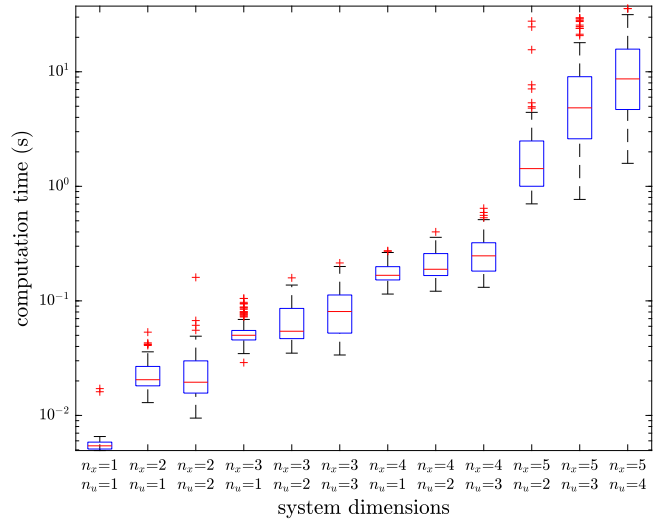
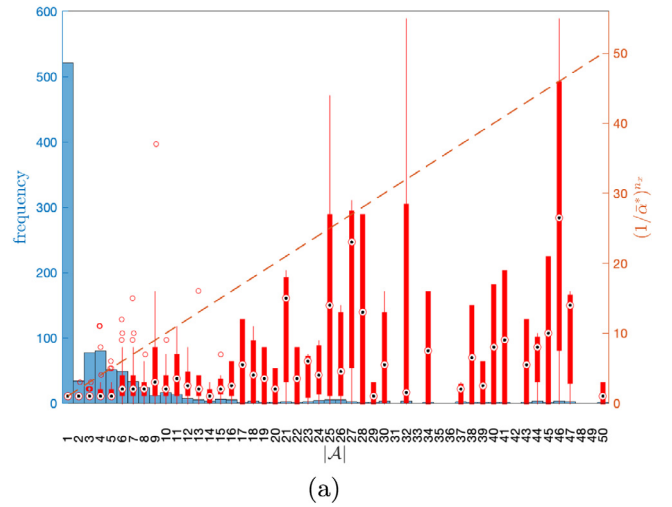

Fig. 8. Computation time of invariant cover with respect to the state dimension  $n_x$  and the control dimension  $n_u$ .



(a)

Fig. 9. In red: box plot of the approximate lower bound  $(1/\bar{\alpha}^*)^{n_x}$  on  $|A|^*$ . In blue: the observed distribution of  $|A|$ . (For interpretation of the references to color in this figure legend, the reader is referred to the web version of this article.)

Suppose that an invariant cover exists for (1) and let

$$\epsilon = \max_{i \in \mathbb{N}_{[1, n_p]}} \max_{x \in \mathbb{Q}} \min_{u \in \mathbb{U}} [PA]_i x + [PB]_i u - [p]_i.$$

Then  $\epsilon \leq 0$  by Lemma 3.2. If  $\epsilon < 0$ , then for all  $x \in \mathbb{Q}$  there necessarily exists  $u \in \mathbb{U}$  so that  $S = I$  and  $r = -\epsilon > 0$  are feasible for (19), (21) and  $S \geq 0$ . For the case in which  $\epsilon = 0$ , let  $\mathcal{I}$  be the set of indices  $i \in \mathbb{N}_{[1, n_p]}$  such that  $[PA]_i x_i^* + [PB]_i u_i^* - [p]_i = 0$ , for some  $x_i^* \in \mathbb{Q}$  and  $u_i^* \in \mathbb{U}$ . Then for all  $x \in \mathbb{Q}$  there exists  $u \in \mathbb{U}$  so that  $[PA]_i x + [PB]_i u - [p]_i \leq \epsilon'$  for all  $i \in \mathbb{N}_{[1, n_p]} \setminus \mathcal{I}$ , for some  $\epsilon' < 0$ . Furthermore, for each  $i \in \mathcal{I}$ ,  $x_i^*$  and  $u_i^*$  are the solutions of the linear programs

$$x_i^* = \arg \max_{x \in \mathbb{Q}} [PA]_i x, \quad u_i^* = \arg \min_{u \in \mathbb{U}} [PB]_i u,$$

and it follows from LP duality that there exist an index set  $\mathcal{J}_i \subseteq \mathbb{N}_{[1, n_q]}$  and scalars  $\lambda_j \geq 0$  such that

$$[PA]_i = \sum_{j \in \mathcal{J}_i} \lambda_j [Q]_j$$

and  $[Q]_j x_i^* - [q]_j = 0$  for all  $j \in \mathcal{J}_i$ . In this case therefore  $S = \begin{bmatrix} S_1 & S_2 \\ 0 & I \end{bmatrix}$ , where  $S_1$  is diagonal and

$$[S_1]_{ii} = \begin{cases} 0 & i \in \mathcal{I}, \\ 1 & i \notin \mathcal{I} \end{cases} \quad [S_2]_{ij} = \begin{cases} \lambda_j & i \in \mathcal{I} \text{ and } j \in \mathcal{J}_i, \\ 0 & i \notin \mathcal{I} \end{cases}$$

satisfies  $S \geq 0$  and (19), and moreover (21) holds for all  $x \in \mathbb{Q}$  with  $r = -\epsilon' > 0$  and some  $u \in \mathbb{U}$ .

To complete the proof we show that an invariant cover necessarily exists for (1) and  $\mathbb{Q}$  if, for all  $x \in \mathbb{Q}$  there exists  $u \in \mathbb{U}$  such that  $\mathbb{B}_r(x) \cap \mathbb{Q} \subseteq \Pi(u)$  for some  $r > 0$ . In this case it is possible to construct a set  $\{x_i^*\}_{i=1}^N$  for some finite  $N$  (where  $N = O(r^{-n_x})$ ) that satisfies: (i)  $\bigcup_{i=1}^N \mathbb{B}_r(x_i^*) \supseteq \mathbb{Q}$ ; and (ii) for all  $i \in \mathbb{N}_{[1,N]}$ ,  $x_i^* \in \mathbb{Q}$  and  $\Pi(u_i^*) \supseteq \mathbb{B}_r(x_i^*) \cap \mathbb{Q}$  for some  $u_i^* \in \mathbb{U}$ .

Therefore an invariant cover exists by Lemma 3.2 and  $|\mathcal{A}|^* \leq N$ .  $\square$

**Proof of Lemma 3.5.** To prove the assertion in (i) we show by contradiction that (13) has a solution for all  $x \in \mathbb{Q} \setminus (1 - \sigma)\mathbb{Q}$  if  $\sigma \leq \bar{\sigma}$ . For  $\sigma \in (0, 1)$  and  $x \in \mathbb{Q} \setminus (1 - \sigma)\mathbb{Q}$ , let  $J_\sigma(x) = \{j \in \mathbb{N}_{[1,n_q]} : [Q]_j x > (1 - \sigma)[q]_j\}$  and define  $\sigma_j$  for each  $j \in \mathbb{N}_{[1,n_q]}$

$$\sigma_j(x) = \begin{cases} ([q]_j - [Q]_j x) / [q]_j & \text{if } j \in J_\sigma(x) \\ \sigma & \text{otherwise} \end{cases}$$

so that  $\sigma_j(x) \in [0, \sigma] \forall j \in J_\sigma(x)$ . Also define  $\mathbb{Q}_\sigma(x) \subseteq \sigma\mathbb{Q}$  as the set

$$\mathbb{Q}_\sigma(x) = \{z \in \mathbb{R}^{n_x} \mid [Q]_j z \leq \sigma_j(x)[q]_j, \forall j \in \mathbb{N}_{[1,n_q]}\}.$$

For each  $j \in J_\sigma(x)$ , there exists  $y = x + z \in \mathbb{Q}$  such that  $[Q]_j y = [q]_j$  for some  $z \in \text{vert}(\mathbb{Q}_\sigma(x))$ .

Suppose that (i) is false and (13) is primal infeasible. Then there exists a pair of indices  $j_1, j_2 \in J_\sigma(x)$  such that the hyperplanes  $\{y \mid [Q]_{j_1} y = [q]_{j_1}\}$  and  $\{y \mid [Q]_{j_2} y = [q]_{j_2}\}$  have no point of intersection in  $\mathbb{Q}$ . But  $[Q]_{j_i} y_i = [q]_{j_i}$  where  $y_i = x + z_i$ ,  $z_i \in \text{vert}(\mathbb{Q}_\sigma(x))$ ,  $i = 1, 2$ , and hence

$$\begin{aligned} [q]_{j_2} - [Q]_{j_2} x &= [q]_{j_2} - [Q]_{j_2} (y_1 - z_1) \\ &\geq \min_{x \in \text{vert}_2(\mathbb{Q})} \{[q]_{j_2} - [Q]_{j_2} x\} + \min_{z \in \mathbb{Q}_\sigma(x)} [Q]_{j_2} z \\ &\geq \min_k \min_{x \in \text{vert}_k(\mathbb{Q})} \{[q]_k - [Q]_k x\} + \sigma \min_{x \in \mathbb{Q}} [Q]_{j_2} x, \end{aligned}$$

where the first inequality follows from  $[Q]_{j_2} y_1 < [q]_{j_2}$  and  $z_1 \in \mathbb{Q}_\sigma(x)$ , and the second inequality from  $\mathbb{Q}_\sigma(x) \subseteq \sigma\mathbb{Q}$ . But  $[q]_{j_2} - [Q]_{j_2} x = \sigma_2 [q]_{j_2} < \sigma [q]_{j_2}$ , which implies

$$\sigma [q]_{j_2} > \min_k \min_{x \in \text{vert}_k(\mathbb{Q})} [q]_k - [Q]_k x + \sigma \min_{x \in \mathbb{Q}} [Q]_{j_2} x,$$

and hence  $\sigma$  must be greater than  $\bar{\sigma}$ . Therefore, if  $\sigma \leq \bar{\sigma}$ , then  $y \in \mathbb{Q}$  and  $z \in \text{vert}(\mathbb{Q}_\sigma(x))$  must exist such that  $y = x + z$  and  $[Q]_j y = [q]_j \forall j \in J_\sigma(x)$ , and it follows that (13) has a solution for all  $x \in \mathbb{Q} \setminus (1 - \sigma)\mathbb{Q}$ .

To prove the assertion in (ii) we show that  $\mathbb{B}_r(x) \cap \mathbb{Q} \subseteq \bar{\mathcal{X}}(y_\sigma(x), \sigma)$  with  $r = \sigma^2 \min_j [q]_j$ . First consider the case in which  $x \in (1 - \sigma)\mathbb{Q}$ . Then  $y_\sigma(x) = x$  so  $\bar{\mathcal{X}}(y_\sigma(x), \sigma) = \bar{\mathcal{X}}(x, \sigma)$  and  $\mathbb{B}_r(x) \subseteq \bar{\mathcal{X}}(x, \sigma)$  if and only if

$$\{z \mid Q(z - x) \leq r\mathbf{1}\} \subseteq \{z \mid Q(z - x) \leq \sigma(q - Qx)\}.$$

The condition holds whenever  $r \leq \min_{j \in \mathbb{N}_{[1,n_q]}} \sigma([q]_j - [Q]_j x)$  but  $x \in (1 - \sigma)\mathbb{Q}$  implies  $q - Qx \geq \sigma q$ , and it follows that  $\mathbb{B}_r(x) \subseteq \bar{\mathcal{X}}(x, \sigma)$  if  $r = \sigma^2 \min_{j \in \mathbb{N}_{[1,n_q]}} [q]_j$ .

Next we determine  $r$  so that  $\mathbb{B}_r(x) \cap \mathbb{Q} \subseteq \bar{\mathcal{X}}(y_\sigma(x), \sigma)$  for the case that  $x \in \mathbb{Q} \setminus (1 - \sigma)\mathbb{Q}$ . The definition of  $y_\sigma(x)$  implies  $[Q]_j y_\sigma(x) = [q]_j$  for all  $j \in J_\sigma(x)$ , and since

$$\begin{aligned} \mathbb{B}_r(x) \cap \mathbb{Q} &\subseteq \{z \mid Q(z - y_\sigma(x)) \\ &\leq \min\{r\mathbf{1} + Q(x - y_\sigma(x)), q - Qy_\sigma(x)\}\}, \end{aligned}$$

we have  $\mathbb{B}_r(x) \cap \mathbb{Q} \subseteq \bar{\mathcal{X}}(y_\sigma(x), \sigma)$  if  $r + [Q]_j(x - y_\sigma(x)) \leq \sigma([q]_j - [Q]_j y_\sigma(x))$  for all  $j \notin J_\sigma(x)$ , or equivalently if

$$r \leq \min_{j \notin J_\sigma(x)} \sigma [q]_j - [Q]_j (x - (1 - \sigma)y_\sigma(x)).$$

But (13) selects  $y_\sigma(x)$  so that the right hand side of this expression is minimized for some  $x \in \text{vert}(\mathbb{Q})$  (since this implies that  $y_\sigma(x) = x \in \text{vert}(\mathbb{Q})$ ), and we therefore have

$$\begin{aligned} &\min_{j \notin J_\sigma(x)} \sigma [q]_j - [Q]_j (x - (1 - \sigma)y_\sigma(x)) \\ &\geq \sigma \min_{j \notin J_\sigma(x)} [q]_j - [Q]_j x \geq \sigma^2 \min_k [q]_k, \end{aligned}$$

where the first inequality is obtained by setting  $y_\sigma(x) = x$  and the second follows from  $[Q]_j x \leq (1 - \sigma)[q]_j$  for all  $j \notin J_\sigma(x)$ . Therefore  $\mathbb{B}_r(x) \cap \mathbb{Q} \subseteq \bar{\mathcal{X}}(y_\sigma(x), \sigma)$  if  $r = \sigma^2 \min_{j \in \mathbb{N}_{[1,n_q]}} [q]_j$ .  $\square$

**Proof of Theorem 3.2.** Every vertex of  $\mathbb{Q}$  corresponds to a critical vertex of  $\Gamma$  if and only if for each  $x \in \text{vert}(\mathbb{Q})$  there exist  $\alpha \in (0, 1]$  and  $u \in \mathbb{U}$  such that  $\bar{\mathcal{X}}(x, \alpha) \subseteq \Pi(u)$ . From (10) it is obvious that  $\alpha > 0$  is necessary for  $\mathbb{B}_r(x) \cap \mathbb{Q} \subseteq \bar{\mathcal{X}}(x, \alpha)$  for some  $r > 0$ . Therefore  $\mathbb{B}_r(x) \cap \mathbb{Q} \subseteq \bar{\mathcal{X}}(x, \alpha) \subseteq \Pi(u)$  for some  $r > 0$  and  $u \in \mathbb{U}$  only if every vertex of  $\mathbb{Q}$  corresponds to a critical vertex of  $\Gamma$ , and it follows from Theorem 3.1 that this is a necessary condition for existence of an invariant cover.

To prove sufficiency, note that for all  $x \in \mathbb{Q}$ ,  $y_\sigma(x)$  can be expressed  $y_\sigma(x) = \sum_{i=1}^N \lambda_i x_i^*$ , with  $\{x_i^*\}_{i=1}^N = \text{vert}(\mathbb{Q})$ ,  $\lambda_i \geq 0$  for all  $i \in \mathbb{N}_{[1,N]}$  and  $\sum_{i=1}^N \lambda_i = 1$ . If every vertex of  $\mathbb{Q}$  corresponds to a critical vertex of  $\Gamma$ , then  $\alpha_i \in (0, 1]$  and  $u_i^* \in \mathbb{U}$  exist for all  $i \in \mathbb{N}_{[1,N]}$  so that  $\bar{\mathcal{X}}(x_i^*, \alpha_i) \subseteq \Pi(u_i^*)$ . Using Lemmas 3.3 and 3.4 we therefore obtain

$$\bar{\mathcal{X}}(y_\sigma(x), \min_{i \in \mathbb{N}_{[1,N]}} \alpha_i) \subseteq \bigoplus_{i=1}^N \lambda_i \bar{\mathcal{X}}(x_i^*, \alpha_i) \subseteq \bigoplus_{i=1}^N \lambda_i \Pi(u_i^*) \subseteq \Pi(u)$$

where  $u = \sum_{i=1}^N \lambda_i u_i^* \in \mathbb{U}$ . Furthermore, Lemma 3.5 implies that  $\mathbb{B}_r(x) \cap \mathbb{Q} \subseteq \bar{\mathcal{X}}(y_\sigma(x), \alpha)$  with  $r = \sigma^2 \min_k [q]_k$  if  $\sigma = \min\{\alpha, \bar{\sigma}\}$ . Therefore  $\min_{i \in \mathbb{N}_{[1,N]}} \alpha_i > 0$  ensures that  $r > 0$  and hence an invariant cover must exist by Theorem 3.1.  $\square$

**Proof of Lemma 3.6.** For given  $x \in \mathbb{Q}$ , (15) determines the maximum value of  $\alpha \in [0, 1]$  such that  $\bar{\mathcal{X}}(x, \alpha) \subseteq \Pi(u)$  for some  $u \in \mathbb{U}$ . Specifically, since  $\bar{\mathcal{X}}(x, \alpha) \subseteq \mathbb{Q}$  for all  $x \in \mathbb{Q}$  and  $\alpha \in [0, 1]$ , we have  $\bar{\mathcal{X}}(x, \alpha) \subseteq \Pi(u)$  if and only if there exists  $u \in \mathbb{U}$  such that  $A\bar{\mathcal{X}}(x, \alpha) \oplus \{Bu\} \subseteq \mathbb{Q} \oplus \mathbb{W}$ . By LP duality, this set inclusion condition holds if and only if a non-negative matrix  $R$  exists satisfying

$$\begin{aligned} RQ &= PA \\ (1 - \alpha)PAx + \alpha Rq + PBu &\leq p. \end{aligned}$$

The variable transformation  $S = \alpha R$  results in a set of constraints that are linear in  $u, \alpha$  and  $S$ . The problem of maximizing  $\alpha$  subject to  $\bar{\mathcal{X}}(x, \alpha) \subseteq \Pi(u)$  and  $u \in \mathbb{U}$  can therefore be expressed as the LP (15).  $\square$

**Proof of Lemma 4.1.** The assertion in (i) directly follows from the definition of the set  $\bar{\mathcal{X}}(x, \sigma)$ . For given  $x \in (1 - \sigma)\mathbb{Q}$ ,  $(\{x\} \oplus \sigma\delta) \subseteq (\{x\} \oplus \sigma\mathbb{Q}) = \bar{\mathcal{X}}((1 - \sigma)^{-1}x, \sigma)$ .

The assertion in (ii) can be demonstrated by showing that  $(\{x\} \oplus \sigma^2\mathbb{Q}) \cap \mathbb{Q} \subseteq \bar{\mathcal{X}}(y_\sigma(x), \sigma)$  using an argument similar to the proof of Lemma 3.5, assertion (ii). For  $\hat{\sigma} > 0$  we have

$$\begin{aligned} (\{x\} \oplus \hat{\sigma}\mathbb{Q}) \cap \mathbb{Q} &= \{z \mid [Q]_j z \leq \min\{[q]_j, \hat{\sigma}[q]_j + [Q]_j x\}, \\ &\forall j \in \mathbb{N}_{[1,n_q]}\}. \end{aligned}$$

Therefore  $(\{x\} \oplus \hat{\sigma}\mathbb{Q}) \cap \mathbb{Q} \subseteq \bar{\mathcal{X}}(y_\sigma(x), \sigma) = \{z \mid Qz \leq \sigma q + (1 - \sigma)Qy_\sigma(x)\}$  if and only if for all  $j \in \mathbb{N}_{[1, n_q]}$ ,

$$\sigma[q_j] + (1 - \sigma)[Q]_j y_\sigma(x) \geq \min\{[q_j], \hat{\sigma}[q_j] + [Q]_j x\}.$$

Recall that  $J_\sigma(x) = \{j \in \mathbb{N}_{[1, n_q]} \mid [Q]_j x > (1 - \sigma)[q_j]\}$  and  $[Q]_j y_\sigma(x) = [q_j]$  for  $j \in J_\sigma(x)$ , from which it follows that for all  $j \in J_\sigma(x)$ ,

$$\sigma[q_j] + (1 - \sigma)[Q]_j y_\sigma(x) = [q_j] \geq \min\{[q_j], \hat{\sigma}[q_j] + [Q]_j x\}.$$

For  $j \notin J_\sigma(x)$ ,  $\sigma[q_j] - [Q]_j(x - (1 - \sigma)y_\sigma(x))$  is minimized over  $x \in \mathbb{Q} \setminus (1 - \sigma)\mathbb{Q}$  when  $x = y_\sigma(x)$ , and we therefore have  $\sigma[q_j] - [Q]_j(x - (1 - \sigma)y_\sigma(x)) = \sigma([q_j] - [Q]_j x) \geq \sigma^2[q_j]$ , and

$$\begin{aligned} \sigma[q_j] + (1 - \sigma)[Q]_j y_\sigma(x) &\geq \sigma^2[q_j] + [Q]_j x \\ &\geq \min\{[q_j], \sigma^2[q_j] + [Q]_j x\} \quad \forall j \notin J_\sigma(x). \end{aligned}$$

It follows that  $(\{x\} \oplus \hat{\sigma}\delta) \cap \mathbb{Q} \subseteq (\{x\} \oplus \hat{\sigma}\mathbb{Q}) \cap \mathbb{Q} \subseteq \bar{\mathcal{X}}(y_\sigma(x), \sigma)$  if  $\hat{\sigma} = \sigma^2$ .  $\square$

**Proof of Theorem 4.1.** We first consider the statement in (a). The lower bound on  $|\mathcal{A}|^*$  in (18) follows directly from the volumetric scaling of the maximal set  $\Pi(u)$  relative to  $\mathbb{Q}$  and the definition of  $v^*$  as  $\max_{u \in \Phi} \text{vol}(\Pi(u))$ . To prove the upper bound on  $|\mathcal{A}|^*$  in (18), we note that by the proof of Theorem 3.2 and Lemma 4.1, for all  $x \in \mathbb{Q}$ ,  $(\{x\} \oplus \sigma^2\delta) \cap \mathbb{Q} \subseteq \bar{\mathcal{X}}(y_\sigma(x), \sigma) \subseteq \Pi(u)$  for some  $u \in \mathbb{U}$ , where  $y_\sigma(x)$  is defined in (13)–(14). The upper bound on  $|\mathcal{A}|^*$  in (18) then follows from an upper bound on the cardinality of a cover of  $\mathbb{Q}$  of the form  $\cup_{i=1}^N (\{x_i\} \oplus \sigma^2\delta)$ , which can be obtained from the ratios of the corresponding sides of the hyperrectangles  $\Delta$  (which contains  $\mathbb{Q}$ ) and  $\sigma^2\delta$ .

To prove the statement in (b), we note that the value of  $\bar{\alpha}^*$  in (17) is the maximum, as  $x$  varies over  $\mathbb{Q}$ , of  $\alpha \in [0, 1]$  such that  $\bar{\mathcal{X}}(x, \alpha) \subseteq \Pi(u)$  for some  $u \in \mathbb{U}$ . This follows from Lemma 3.6, which implies that  $\bar{\alpha}^* = \max_{x \in \mathbb{Q}} \alpha^*(x)$ . Furthermore from (10) we have  $\bar{\mathcal{X}}(x, \alpha) = \mathbb{Q}$  if and only if  $\alpha = 1$ , and it follows that  $\mathcal{A} = \mathbb{Q}$  (and hence  $|\mathcal{A}|^* = 1$ ) if and only if  $\bar{\alpha}^* = 1$ . In this case  $G(\mathbb{Q})$  is simply equal to  $u^*$ , the optimal value of  $u$  in (16).  $\square$

**Proof of Theorem 5.1.** We demonstrate that Algorithm 1 terminates in finite time whenever an invariant cover exists for the system (1) and set  $\mathbb{Q}$  by showing that PARTITION( $\bar{\mathbb{Y}}$ ) in line 21 can only be invoked a finite number of times if  $\alpha^* > 0$ . Since  $\sigma$  is defined in line 10 as  $\min\{\bar{\sigma}, \alpha^*\}$ , Lemma 3.5 implies that each pair  $(x, u)$  computed in lines 13 and 16 satisfies  $\mathbb{B}_r(x) \cap \mathbb{Q} \subseteq \bar{\mathcal{X}}(y_\sigma(x), \sigma) \subseteq \Pi(u)$  with  $r = \sigma^2 \min_j [q_j] > 0$  if  $\alpha^* > 0$ . Therefore  $\mathbb{Y}_0$  computed in line 18 satisfies  $\mathbb{B}_r(x) \cap \bar{\mathbb{Y}} = \mathbb{B}_r(x) \cap \mathbb{Q} \cap \bar{\mathbb{Y}} \subseteq \Pi(u) \cap \bar{\mathbb{Y}} = \mathbb{Y}_0$ , so that each vertex of  $\mathbb{Y}_0$  that is not a vertex of  $\bar{\mathbb{Y}}$  is necessarily of a distance of at least  $r$  from  $x$ . Since  $x$  is defined as a vertex of  $\bar{\mathbb{Y}}$  in line 13, it follows that PARTITION( $\bar{\mathbb{Y}}$ ) can be called only a finite number of times before  $\mathcal{A}$  covers  $\mathbb{Q}$ .  $\square$

## References

Adler, R. L., Konheim, A. G., & McAndrew, M. H. (1965). Topological entropy. *Transactions of the American Mathematical Society*, 2(114), 309–319.

Agarwal, Y., Balaji, B., Gupta, R., Lyles, J., Wei, M., & Weng, T. (2010). Occupancy-driven energy management for smart building automation. In *Proceedings of the 2nd ACM workshop on embedded sensing systems for energy-efficiency in building* (pp. 1–6).

Avis, D. (2000). Lrs: A revised implementation of the reverse search vertex enumeration algorithm. In G. Kalai, & G. Ziegler (Eds.), *Polytopes - combinatorics and computation* (pp. 177–198). Birkhauser-Verlag.

Bemporad, A., Heemels, M., & Johansson, M. (2010). *Networked control systems*. Springer.

Bemporad, A., Morari, M., Dua, V., & Pistikopoulos, E. N. (2002). The explicit linear quadratic regulator for constrained systems. *Automatica*, 1(38), 3–20.

Blanchini, F. (1999). Set invariance in control. *Automatica*, 11(35), 1747–1767.

Blanchini, F., & Miani, S. (2007). *Set-theoretic methods in control*. Springer.

Bowen, R. (1971). Entropy for group endomorphisms and homogeneous spaces. *Transactions of the American Mathematical Society*, (153), 401–414.

Colonius, F., Kawan, C., & Nair, G. N. (2013). A note on topological feedback entropy and invariance entropy. *Systems & Control Letters*, 5(62), 377–381.

Gal, T. (1995). *Postoptimal analyses, parametric programming, and related topics* (2nd ed.). Berlin: de Gruyter.

Henk, M., Richter-Gebert, J., & Ziegler, G. M. (2017). Basic properties of convex polytopes. In *Handbook of discrete and computational geometry* (3rd ed.). CRC Press.

Kawan, C. (2013). *Invariance entropy for deterministic control systems: An introduction*. Springer.

Lai, S., Lan, M., & Chen, B. M. (2019). Model predictive local motion planning with boundary state constrained primitives. *IEEE Robotics and Automation Letters*, 4(4), 3577–3584.

Lunze, J. (2014). *Control theory of digitally networked dynamic systems*. Springer.

Nair, G. N., & Evans, R. J. (2003). Exponential stabilisability of finite-dimensional linear systems with limited data rates. *Automatica*, 4(39), 585–593.

Nair, G. N., Evans, R. J., Mareels, I. M. Y., & Moran, W. (2004). Topological feedback entropy and nonlinear stabilization. *IEEE Transactions on Automatic Control*, 9(49), 1585–1597.

Nair, G. N., Fagnani, F., Zampieri, S., & Evans, R. J. (2007). Feedback control under data rate constraints: An overview. *Proceedings of the IEEE*, 1(95), 108–137.

Rungger, M., & Tabuada, P. (2017). Computing robust controlled invariant sets of linear systems. *IEEE Transactions on Automatic Control*, 7(62), 3665–3670.

Rungger, M., & Zamani, M. (2017). Invariance feedback entropy of nondeterministic control systems. In *Proceedings of ACM international conference on hybrid systems: computation and control* (pp. 91–100).

Rungger, M., & Zamani, M. (2017). On the invariance feedback entropy of linear perturbed control systems. In *Proceedings of IEEE 56th conference on decision and control* (pp. 3998–4003).

Schneider, R. (2014). Convex bodies: the brunn–Minkowski theory: 2nd expanded edition. In *Encyclopedia math. appl. (vol. 151)*. Cambridge University Press.

Sinopoli, B., Schenato, L., Franceschetti, M., Poolla, K., Jordan, M. I., & Sastry, S. S. (2004). Kalman filtering with intermittent observations. *IEEE Transactions on Automatic Control*, 9(49), 1453–1464.

Tatikonda, S., & Mitter, S. (2004). Control under communication constraints. *IEEE Transactions on Automatic Control*, 7(49), 1056–1068.

Tomar, M. S., Rungger, M., & Zamani, M. (2020). Invariance feedback entropy of uncertain control systems. *IEEE Transactions on Automatic Control*.

Zhang, W., Branicky, M. S., & Phillips, S. M. (2001). Stability of networked control systems. *IEEE Control Systems Magazine*, 1(21), 84–99.

Zhou, B., Cao, J., Zeng, X., & Wu, H. (2010). Adaptive traffic light control in wireless sensor network-based intelligent transportation system. In *Proceedings of IEEE 72nd vehicular technology conference-fall* (pp. 1–5).



**Yulong Gao** received the B.E. degree in Automation in 2013, the M.E. degree in Control Science and Engineering in 2016, both from Beijing Institute of Technology, and the joint Ph.D. degree in Electrical Engineering in 2021 from KTH Royal Institute of Technology and Nanyang Technological University. He was a visiting student in Department of Computer Science, University of Oxford in 2019. His research interests include automatic verification, stochastic control and model predictive control with application to safety-critical systems.



**Mark Cannon** obtained the MEng degree in engineering science and the DPhil degree in control engineering from the University of Oxford in 1993 and 1998 respectively, and the MS degree from Massachusetts Institute of Technology in 1995. He is currently an Associate Professor of Engineering Science at the University of Oxford and a Fellow of St John's College, Oxford. His research interests include robust and optimal control for constrained and uncertain systems, optimization for receding horizon control with robust constraints, and stochastic model predictive control with applications

in energy management and resource allocation.



**Lihua Xie** received the B.E. and M.E. degrees in electrical engineering from Nanjing University of Science and Technology in 1983 and 1986, respectively, and the Ph.D. degree in electrical engineering from the University of Newcastle, Australia, in 1992. Since 1992, he has been with the School of Electrical and Electronic Engineering, Nanyang Technological University, Singapore, where he is currently a professor and Director, Delta-NTU Corporate Laboratory for Cyber-Physical Systems. He served as the Head of Division of Control and Instrumentation from July 2011 to June 2014. He held teaching appointments in the Department of Automatic Control, Nanjing University of Science and Technology from 1986 to 1989.

Dr Xie's research interests include robust control and estimation, networked control systems, multi-agent networks, localization and unmanned systems. He is an Editor-in-Chief for Unmanned Systems and an Associate Editor for IEEE Transactions on Network Control Systems. He has served as an editor of IET Book Series in Control and an Associate Editor of a number of journals including IEEE Transactions on Automatic Control, Automatica, IEEE Transactions on Control Systems Technology, and IEEE Transactions on Circuits and Systems-II. He was an IEEE Distinguished Lecturer (Jan 2012–Dec 2014) and an elected member of Board of Governors, IEEE Control System Society (Jan 2016–Dec 2018). Dr Xie is a Fellow of IEEE, a Fellow of IFAC, and a Fellow of Academy of Engineering Singapore.



**Karl Henrik Johansson** received M.Sc. and Ph.D. degrees from Lund University. He is a professor with the School of Electrical Engineering and Computer Science at KTH Royal Institute of Technology in Sweden and Director of Digital Futures. He has held visiting positions at UC Berkeley, Caltech, NTU, HKUST Institute of Advanced Studies, and NTNU.

His research interests are in networked control systems and cyber-physical systems with applications in transportation, energy, and automation networks.

He is a member of the Swedish Research Council's Scientific Council for Natural Sciences and Engineering Sciences. He has served on the IEEE Control Systems Society Board of Governors, the IFAC Executive Board, and is currently Vice-President of the European Control Association. He has received several best paper awards and other distinctions from IEEE, IFAC, and ACM. He has been awarded Distinguished Professor with the Swedish Research Council and Wallenberg Scholar with the Knut and Alice Wallenberg Foundation. He has received the Future Research Leader Award from the Swedish Foundation for Strategic Research and the triennial Young Author Prize from IFAC. He is Fellow of the IEEE and the Royal Swedish Academy of Engineering Sciences, and he is IEEE Control Systems Society Distinguished Lecturer.